

Statistical Thermodynamics and Spectroscopy

Dr Wolfgang Schärfl

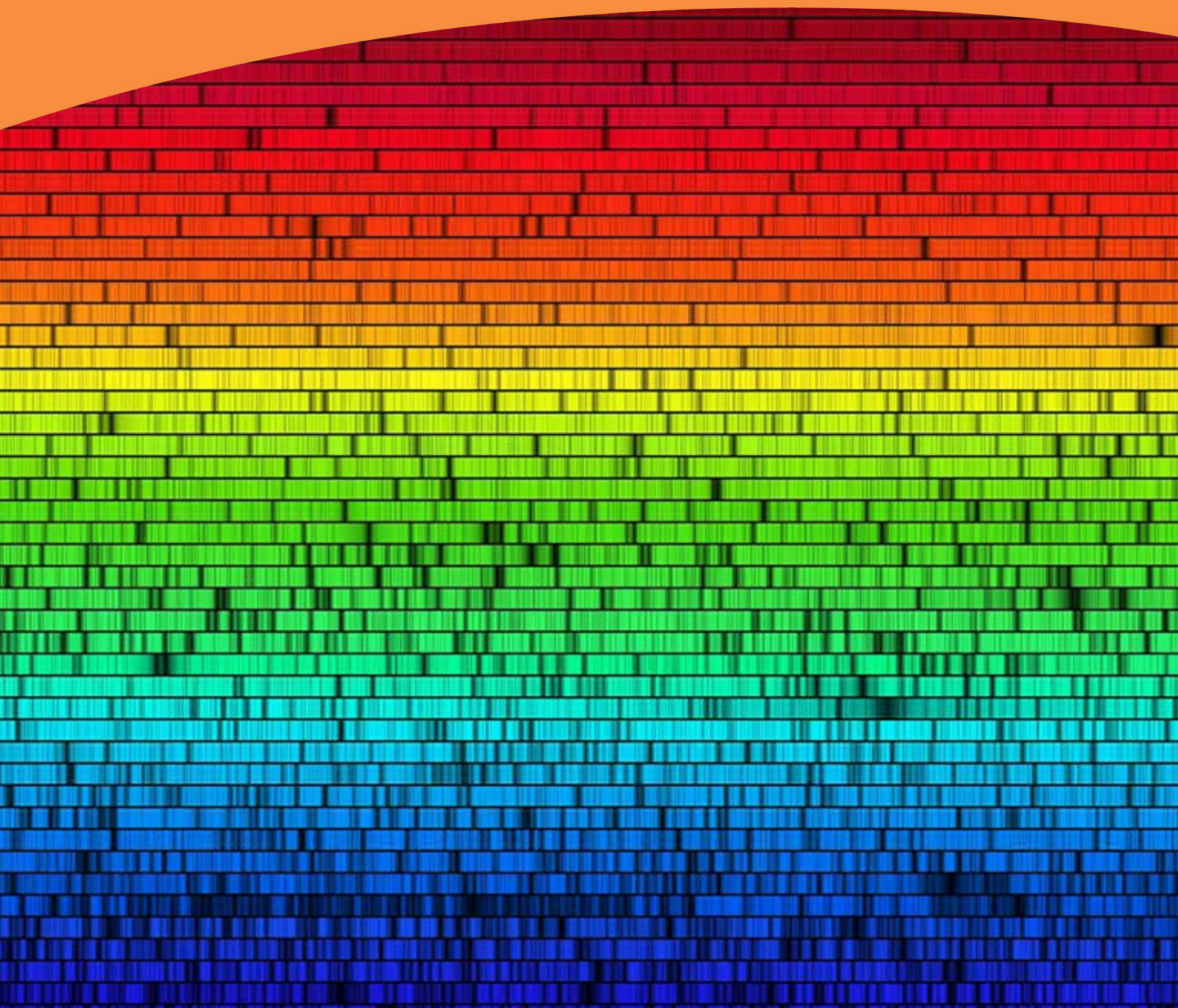

Wolfgang Schärftl

Statistical Thermodynamics and Spectroscopy

How Classical Thermodynamics Relates
to Quantum Chemistry



Statistical Thermodynamics and Spectroscopy:
How Classical Thermodynamics Relates to Quantum Chemistry
1st edition
© 2015 Wolfgang Schärfl & bookboon.com
ISBN 978-87-403-1122-8

Contents

Prologue	6
1 Statistical thermodynamics	8
1.1 The Boltzmann statistics	10
1.2 Calculation of molecular partition functions	14
1.3 The molecular partition function and macroscopic thermodynamic properties	21
1.4 Heat capacities of gases, and characteristic temperatures	26
1.5 Statistical thermodynamics and chemical equilibrium	29
2 Optical spectroscopy	35
2.1 Mathematical background – complex numbers	35
2.2 Principles of spectroscopy	42
2.3 Quantum mechanical treatment of spectroscopy	49
2.4 Optical spectroscopic methods	56

Free eBook on Learning & Development

By the Chief Learning Officer of McKinsey

[Download Now](#)

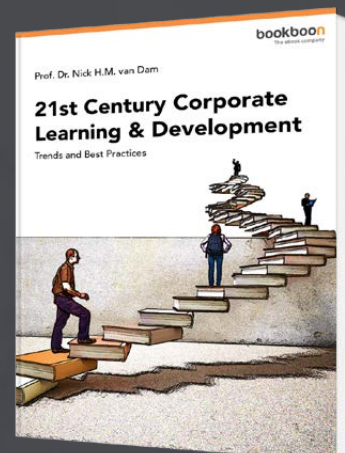

3	Group theory	67
3.1	C_{2v} – a simple example to introduce the concept	67
3.2	The point group C_{3v}	75
3.3	T_d	79
3.4	Group theory and excitation of molecular electronic transitions, e.g. C_{2v}	83
	Index	90



www.sylvania.com

We do not reinvent
the wheel we reinvent
light.

Fascinating lighting offers an infinite spectrum of possibilities: Innovative technologies and new markets provide both opportunities and challenges. An environment in which your expertise is in high demand. Enjoy the supportive working atmosphere within our global group and benefit from international career paths. Implement sustainable ideas in close cooperation with other specialists and contribute to influencing our future. Come and join us in reinventing light every day.

Light is OSRAM

**OSRAM
SYLVANIA** 

Prologue

The concept of classical thermodynamics provides a purely phenomenological approach towards energy transfer, phase equilibria and chemical equilibria. Therefore, its application to predict the behavior of real systems quantitatively is rather limited, for instance in respect to the heat capacities of gases and the quantitative dependence of these heat capacities on temperature. Also, classical thermodynamics addresses only the changes in quantities of state, such as internal energy, entropy or Gibbs free enthalpy, and therefore, reference states to define the absolute quantities are introduced in an arbitrary way. Finally, classical thermodynamics is a macroscopic approach not at all related to the microscopic properties of matter (atoms, molecules). These microscopic properties of matter, on the other hand, have to be described using the concepts of quantum mechanics.

Here, statistical thermodynamics, which is based on mathematical statistics, provides the connection between the macroscopic physicochemical quantities addressed in classical thermodynamics, and the microscopic quantum chemical description of matter. To calculate the properties of molecules and atoms as predicted by quantum chemistry, on the other hand, we need certain input parameters such as the chemical bond strengths or chemical bond lengths of a given molecule, quantities which can experimentally be determined by optical spectroscopic methods.

This booklet therefore tries to provide an overview on the relation between our quantum chemical description of matter (on the microscopic level) and the macroscopic thermodynamics (macroscopic level), and it is organized as following:

In Chapter 1, I will first introduce the mathematical concept of Boltzmann statistics, which will directly lead us to the fundamental quantity of statistical thermodynamics, the molecular partition function. Next, I will explicitly calculate the partition functions at given temperature for different types of molecular energy levels, using the results from quantum chemistry (namely, harmonic oscillator, rotator, particle in a box). Finally, it will be shown how classical thermodynamic properties, like heat capacity, energy, or entropy etc., depend on the microscopic properties of matter, namely the energy Eigenvalues, via the partition function. I will conclude the first chapter of this book with the explicit calculation of the chemical equilibrium constant for a simple chemical reaction, using the microscopic particle properties to calculate the underlying molecular or atomic partition functions.

Chapter 2 starts with a brief introduction into the mathematical concept of complex numbers, which are needed to facilitate the algebraic calculations with wave functions and mathematical operators in the context of quantum mechanical concepts. This section is followed by a theoretical introduction into the quantum chemistry treatment of optical spectroscopy, which is based on the time-dependent Schrödinger equation and simple linear perturbation theory, as well as an approach using the time-dependent linear combination of unperturbed wave functions to mathematically describe the perturbed state of a molecular system. Next, some important spectroscopic techniques will be briefly discussed: UV/Vis absorption spectroscopy of molecules (corresponding to the excitation of electronic states by the absorption of light), IR absorption spectroscopy (corresponding to the excitation of vibrations and rotations of molecules), and, as an important pendant to the IR technique, Raman scattering spectroscopy.

To determine if molecular vibrations can be detected in IR absorption or Raman scattering, the important concept of symmetry analysis of molecular vibrations based on symmetry point group theory and so-called character tables is a very helpful tool. Therefore, I decided to also include a brief introduction into the mathematical concept of symmetry point groups and character tables in this book, presented in chapter 3. For given comparatively simple example molecules, here it will be illustrated how one can determine the number of optical transitions visible in optical vibration spectroscopy (IR-absorption, Raman scattering). Symmetry analysis is also very useful to analyze the possibility to excite electronic molecular states by UV/vis absorption, which is shown for the example H_2O at the end of chapter 3.

For illustration of the Physical-Chemical concepts and their relevance, chapters 1 and 2 will also contain some quantitative example problems, presented in a box.

1 Statistical thermodynamics

In this chapter, it will be shown how macroscopic thermodynamic quantities can be calculated from molecular parameters, such as strength or length of a chemical bond. The underlying concept is based on mathematical statistics and calculation of average properties from single particle properties. On the other hand, the characteristic properties of a single particle (on an atomistic length scale) are given by quantum chemical calculations. The chapter is organized as following: first, the concept of Boltzmann statistics is presented, leading to the molecular partition function as the fundamental quantity in statistical thermodynamics. In the 2nd part, the general concept will be applied to various quantum mechanical models. These specific solutions allow us, as shown in the third part of this chapter, to calculate thermodynamic quantities such as the heat capacities of molecules in the gas state, or even a chemical equilibrium constant.

Before we start with statistical thermodynamics itself, however, let us briefly recall some fundamental relations from classical phenomenological thermodynamics:

Summary of classical thermodynamic quantities of state and important differential relations:

- (i) Change of internal energy, ΔU :
The change of the internal energy during a process corresponds to the heat exchange with the environment, at isochor (= at constant volume V) conditions: $\Delta U_V = c_V \cdot \Delta T$, with c_V the respective heat capacity. Note that $c_V = c_V(T)$
- (ii) Change of enthalpy, ΔH :
The change of the enthalpy during a process corresponds to the heat exchange with the environment, at isobar (= at constant pressure p) conditions: $\Delta H_p = c_p \cdot \Delta T$, with c_p the respective heat capacity.

- (iii) Change of entropy, ΔS :
The change of the entropy corresponds to the reversibly exchanged heat divided by the temperature, if the process is run isotherm (= at constant temperature T). If the temperature is not constant, it is more generally given as,

$$\Delta S = \int \frac{dQ_{rev}}{T} dT$$

- (iv) Change of free enthalpy, ΔG :
The change of the free enthalpy is the maximum work output one can get from a process at isotherm and isobar conditions, any volume change effect excluded. For example, this could be electrochemical work (EMK is electromotoric force, e.g. voltage of a chemical battery):

$$\Delta G_{T,p} = W_{rev}' = -z \cdot F \cdot EMK = \Delta H - T \cdot \Delta S$$

- (v) The chemical equilibrium:
The chemical equilibrium constant K_x is related to the difference in free enthalpy of pure products and educts $\Delta_R G^*$, and the thermal energy $R \cdot T$, as:

$$\Delta_R G^* = -R \cdot T \cdot \ln K_x$$

- (vi) Important differential relations for thermodynamic quantities of state:

$$dU = TdS - pdV \qquad dH = TdS + Vdp$$

$$dA = -SdT - pdV \qquad dG = -SdT + Vdp$$

$$c_V = \left(\frac{\partial U}{\partial T}\right)_V \qquad c_p = \left(\frac{\partial H}{\partial T}\right)_p$$

(A : free energy or Helmholtz energy)

1.1 The Boltzmann statistics

Consider a system of N non-interacting distinguishable particles. Each particle can assume a certain energy level E_i , with multiple particles N_i occupying the same energy level. Now, we determine the statistical weight Ω of a given set of energy level populations $\{N_i\}$, using the boundary conditions of constant overall particle number N , constant total energy $E = \sum N_i E_i$, and constant volume of the system (so the energy levels E_i remain constant, just their population N_i is variable).

$$\Omega = \frac{N!}{\prod N_i!} \quad (\text{Eq.1.1})$$

To determine the set of populations N_i with the highest statistical probability, we need to differentiate this expression by all variables N_i , calculate the total differential $d\Omega$ as the sum of these partial differentials, and finally determine the 0 intercept. Since it is not possible to analytically differentiate the ! – function, the so-called Stirling approximation is needed to translate the !-function into a mathematical expression which analytically can be differentiated:

$$\ln \Omega = \ln N! - \sum \ln N_i! \quad (\text{Eq.1.2})$$

with the Stirling approximation:

$$\ln N! = N \ln N - N \quad (\text{Eq.1.3.1})$$

$$\ln N_i! = N_i \ln N_i - N_i \quad (\text{Eq.1.3.2})$$

In Eq.1.2, we have also used that $\sum N_i = N$. Note that the Stirling approximation is only valid for very large numbers N or N_i , respectively.

In addition, to determine the maximum of $\ln \Omega$ in dependence of variables N_i by differentiation, we also have to take into account the boundary conditions of constant particle number and constant total energy of the system. These boundary conditions in differential form are given as:

$$\sum dN_i = 0 \quad (\text{Eq.1.4.1})$$

$$\sum E_i dN_i = 0 \quad (\text{Eq.1.4.2})$$

Before providing the general mathematical solution for the energy level populations $\{N_i\}$ with highest statistical probability Ω_{max} , let us illustrate this concept with a simple example: consider a collection of three dice each with different colors (red, blue, orange), representing the energetic state of a given particle. In addition, we assume a total energy $E = 10$ (here: sum of all 3 dice). This can be realized by the following possibilities shown in figure 1.1:

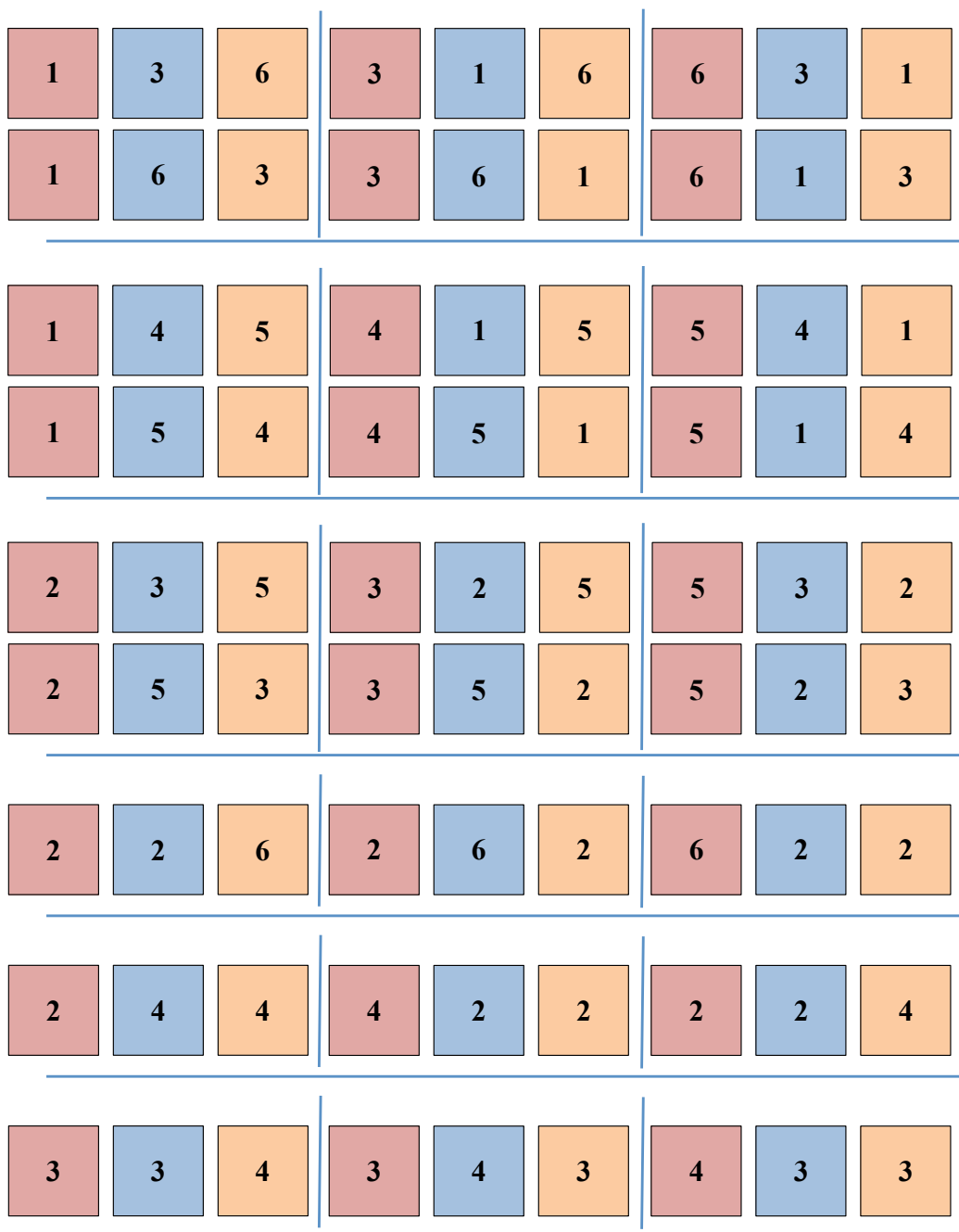

Figure 1.1.: 3 different colored dice representing individual particles in respective energetic states, and all possible combinations corresponding to a total energy E = 10.

According to figure 1.1., we can realize the individual combinations of dice numbers including respective permutations as following: (1,3,6) = 6 possibilities, (1,4,5) = 6 possibilities, (2,3,5) = 6 possibilities, (2,2,6) = 3 possibilities, (2,4,4) = 3 possibilities, and finally (3,3,4) = 3 possibilities. This is in agreement with Eq. (1.1.), as shown for example for combination (3,3,4):

$$\Omega = \frac{N!}{\prod N_i!} = \frac{3!}{2! \cdot 1!} = \frac{3 \cdot 2 \cdot 1}{2 \cdot 1 \cdot 1} = 3 \tag{Eq.1.5}$$

For our simple example we conclude that combinations (1,3,6), (1,4,5) and (2,3,5) have the highest probabilities Ω .

More general, the differential equation to determine Ω_{max} is given by:

$$d \ln \Omega_{max} = 0 = \sum \left\{ \frac{d \ln \Omega}{d N_i} + \alpha - \beta E_i \right\} d N_i \quad (\text{Eq.1.6})$$

with α and β the so-called Lagrange multipliers. For the Lagrange multiplier β , for example, it can be shown (see textbooks of Physical Chemistry) that it is given as:

$$\beta = \frac{1}{k_B \cdot T} \quad (\text{Eq.1.7})$$

T is the absolute temperature of the system measured in Kelvin, and $k_B = 1.38 \cdot 10^{-23} \text{ J/K}$ is the Boltzmann constant. $k_B \cdot T$ then is the thermal energy per particle. In section 1.3, it will be explained in more detail how general relations between the statistical variables q and β on one hand, and phenomenological thermodynamic variables S , U , A and T , can be derived. These relations are based on the fundamental equation of phenomenological thermodynamics $A = U - T \cdot S$ (A = Helmholtz free energy, U = internal energy, S = entropy).



Discover the truth at www.deloitte.ca/careers

Deloitte.

© Deloitte & Touche LLP and affiliated entities.



Click on the ad to read more

For the explicit mathematical solution of the differential equation (1.6.) the interested reader is referred to the literature, i.e. most common textbooks on Physical Chemistry. Here, for simplicity and to keep our focus on the essential concepts, we just continue with the solution:

$$\frac{N_i}{N} = \frac{\exp(-\beta \cdot E_i)}{\sum \exp(-\beta \cdot E_i)} = \frac{\exp\left(-\frac{E_i}{k_B \cdot T}\right)}{\sum \exp\left(-\frac{E_i}{k_B \cdot T}\right)} = \frac{\exp\left(-\frac{E_i}{k_B \cdot T}\right)}{q} \quad (\text{Eq.1.8})$$

with the molecular partition function:

$$q = \sum \exp\left(-\frac{E_i}{k_B \cdot T}\right) = \sum \exp(-\beta \cdot E_i) \quad (\text{Eq.1.9})$$

The meaning of this partition function can be illustrated by a system consisting of two different energy levels only, for example one level at $E_0 = 0 \text{ J/Mole}$, and the other at $E_1 = 100 \text{ J/Mole} = 1.66 \cdot 10^{-22} \text{ J/particle}$. In this case, the partition function is simply given as:

$$q = 1 + \exp\left(-\frac{1.66 \cdot 10^{-22}}{k_B \cdot T}\right) = 1 + \exp\left(-\frac{12.02 \text{ K}}{T}\right) \quad (\text{Eq.1.10})$$

Figure 1.2. illustrates this result:

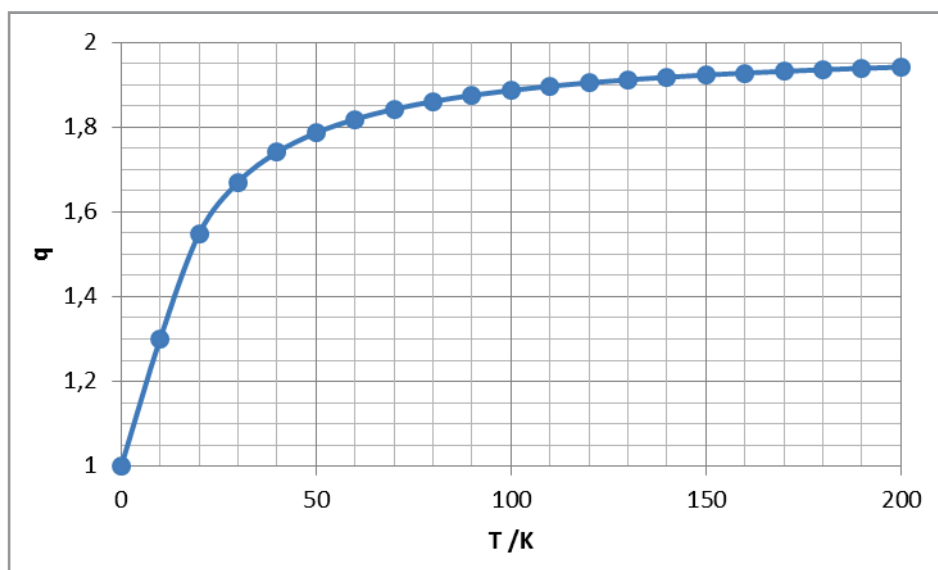

Figure 1.2.: Molecular partition function for a two-state system ($E_0 = 0 \text{ J/Mole}$, $E_1 = 100 \text{ J/Mole} = 1.66 \cdot 10^{-22} \text{ J/particle}$) as a function of temperature. (Plots were prepared with Microsoft Excel 2010)

The partition function provides an estimate for the number of states which are significantly populated at a given temperature T . As shown in figure 1.2., at $T = 0$ K only the ground state is populated, corresponding to $q = 1$. At $T > 200$ K, q assumes nearly a value of 2, corresponding to equal population probability of the ground state and the excited state, and therefore the number of populated states weighted by population probability assumes the value of 2 at high temperatures. It should be noted that an energy of 100 J/Mole is not very much on a molecular scale, since the excited state is maximum populated already at rather low temperature well below $t = 0$ °C or $T = 273.1$ K. Finally, it should be noted here that according to Eq. (1.8), at given temperature the population N_i should steadily decrease with increasing energy E_i . Only at infinitely high temperature $T \rightarrow \infty$ it is possible to achieve an equal population of all states, $N_i = N/q_{max}$, but it never is possible to populate an energetically higher state more than an energetically lower state using heat (thermal energy). q_{max} here is the total number of states.

1.2 Calculation of molecular partition functions

In this section, I will show how molecular partition functions can be calculated at given temperature for different types of molecular energy levels, using the results from quantum chemistry (namely, harmonic oscillator, rotator, particle in a box). Therefore, let me first repeat briefly the solutions of simple quantum chemistry for E_i (see, for example, W. Schärfl, bookboon: “Physical Chemistry – A complete introduction on bachelor of science level”):

i) Particle in a box with infinitely high walls:

In case the potential barrier is infinitely high, the probability to find a particle, moving within a 1-dimensional box of size a , is zero at each wall, and the quantum chemical wave function $\Psi(x)$ then is given as a perfect standing wave (sine- or cosine-function). With decreasing wavelength, the energy increases, since, according to classical physics and the de-Broglie equation ($p = h/\lambda$), the kinetic energy is given as:

$$E = \frac{1}{2}mv^2 = \frac{p^2}{2m} = \frac{h^2/\lambda^2}{2m} \quad (\text{Eq.1.11})$$

with m the particle mass, v the particle velocity, p the momentum of the moving particle, λ the corresponding wave length defined by the de-Broglie equation, and finally h the Planck constant ($h = 6.626e - 34 \text{ J} \cdot \text{s}$).

Since for our particle in a box the wavelengths decrease as 1, 1/2, 1/3, ... (from the ground state to the excited states), we expect the energy levels to scale as 1, 4, 9, ..., even without exactly solving the Schrödinger equation. The wave functions $\Psi(x)$ and the corresponding E_n – eigenvalues are given in figure 1.3:

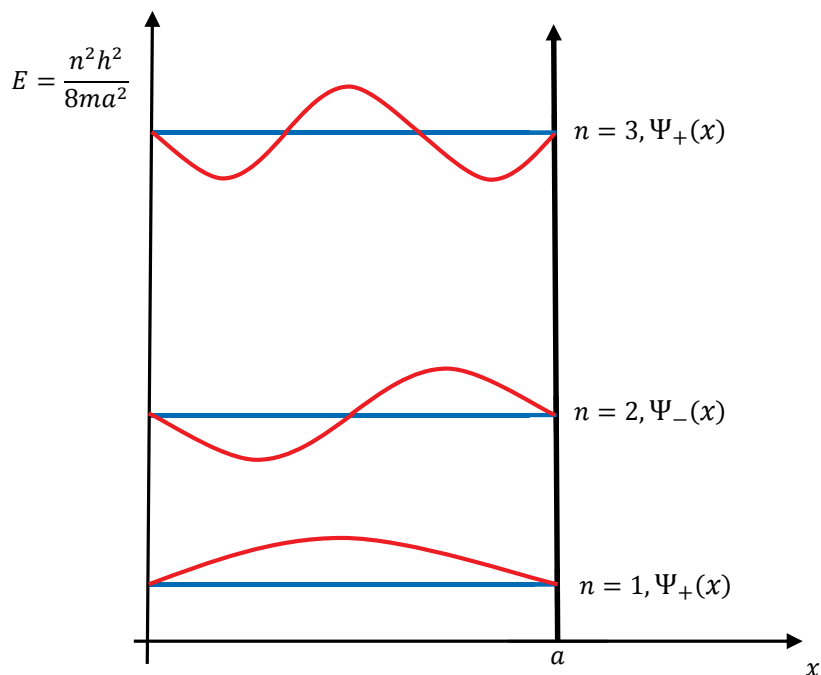

Figure 1.3.: Wave functions and energy Eigenvalues of 1-dimensional particle in a box-problem

Here, + and - define the symmetry of the wave function in respect to the center of the box: + means symmetric, - antymmetric.

SIMPLY CLEVER

ŠKODA



We will turn your CV into an opportunity of a lifetime



Do you like cars? Would you like to be a part of a successful brand? We will appreciate and reward both your enthusiasm and talent. Send us your CV. You will be surprised where it can take you.

Send us your CV on www.employerforlife.com



Click on the ad to read more

According to the respective changes in wavelength with increasing quantum number of the standing waves within the box (see above), the energies depend on an integrate quantum number $E_n \sim n^2$, $n = 1, 2, \dots$. Note that the lowest energy level is not zero, which is obvious from fig.1.3 since the corresponding wave function has a finite wavelength. This finite energy of the ground state is also in agreement with the Heisenberg relation, since zero energy would correspond to an exactly defined momentum. In combination with a particle position limited within the box, this would, in violation of the Heisenberg uncertainty relation, lead to $\Delta p_x \cdot \Delta x = 0$.

For a 3-dimensional box, the energy levels depend on a set of three independent quantum numbers, the particle mass, and the box size, as:

$$E_{n_x, n_y, n_z} = \frac{h^2}{8 \cdot m \cdot a^2} \cdot (n_x^2 + n_y^2 + n_z^2) \quad (\text{Eq.1.12})$$

We will use this quantum mechanical model later to calculate molecular partition functions for translational energy levels of molecules in the gaseous state.

ii) Harmonic oscillator:

Our second quantum mechanical model is the so-called harmonic oscillator, important to determine the energy levels of the oscillations of chemical bonds within molecules. Like in a simple spring model, where the force pulling back the spring is described by Hooke's law ($F = -kx$, with k the spring constant), the potential energy is given as:

$$V = - \int F dx = \frac{1}{2} k x^2 \quad (\text{Eq.1.13})$$

The Schrödinger equation yields the following solutions for the discrete energy levels:

$$E_v = h \cdot \nu_0 \cdot \left(v + \frac{1}{2} \right), \quad v = 0, 1, 2, \dots \quad (\text{Eq.1.14})$$

with basic oscillation frequency ν_0 depending on the spring constant k and the moving mass m as

$$\nu_0 = \sqrt{\frac{k}{m}} \quad (\text{Eq.1.15})$$

Note that in this equation defining the frequency of the harmonic oscillator ν_0 , m is the so-called reduced mass, which for oscillations of biatomic molecules with atomic masses m_1 and m_2 , respectively, is defined as:

$$m = \frac{m_1 \cdot m_2}{m_1 + m_2} \quad (\text{Eq.1.16})$$

This model will be used further below to calculate molecular partition functions for vibrational energy levels of simple molecules in the gaseous state.

iii) Rotator

For molecular rotation, the energy eigenvalues (= solutions of the Schrödinger equation) are given as

$$E_J = h \cdot c \cdot B \cdot J \cdot (J + 1), \quad J = 0, 1, 2, \dots \quad (\text{Eq.1.17})$$

with the rotation constant B depending on the momentum of inertia of the rotating molecule I as:

$$B = \frac{h}{8\pi^2 c I} \quad \text{and} \quad I = \sum m_i s_i^2 \quad (\text{Eqs.1.18})$$



e-learning for kids

- The number 1 MOOC for Primary Education
- Free Digital Learning for Children 5-12
- 15 Million Children Reached

About e-Learning for Kids Established in 2004, e-Learning for Kids is a global nonprofit foundation dedicated to fun and free learning on the Internet for children ages 5 - 12 with courses in math, science, language arts, computers, health and environmental skills. Since 2005, more than 15 million children in over 190 countries have benefitted from eLessons provided by EFK! An all-volunteer staff consists of education and e-learning experts and business professionals from around the world committed to making difference. eLearning for Kids is actively seeking funding, volunteers, sponsors and courseware developers; get involved! For more information, please visit www.e-learningforkids.org.

Here, m_i is the mass of the atom i of the molecule, and s_i the distance of this atom to the molecule's center of mass. For diatomic molecules, we simply get $I = m_1 s_1^2 + m_2 s_2^2$, with the length of the chemical bond given as $l = s_1 + s_2$.

Note that the energetic levels, like in the case of a particle in a 3d-box, are degenerate, with the degree of degeneration given as $g_J = 2J + 1$.

We will use this last model later to calculate molecular partition functions for rotational energy levels of simple molecules in the gaseous state.

With these quantum chemical solutions of the energy eigenvalues E_i , we can now derive mathematical expressions for the respective partition functions in dependence of temperature T :

A) Partition function of translational energy levels (particle in a box):

As we have just shown above, the energy for a particle moving within a defined 1-dimensional box with side length a is given as:

$$E_n = \frac{n^2 h^2}{8ma^2} \quad (\text{Eq.1.19})$$

Compared to the thermal energy $k_B \cdot T = \beta^{-1}$, the energy differences $\Delta E = E_{n+1} - E_n$ in this case are very small. Therefore, the sum in the partition function can mathematically be replaced by an integral. To consider a 3d-system, we have to calculate the 3rd power of the 1d-solution, since the particle motions in directions x , y , z are statistically independent, i.e.:

$$q_{tr,3d} = (q_{tr,1d})^3 \quad (\text{Eq.1.20})$$

with

$$q_{tr,1d} = \sum_{n=1}^{\infty} \exp\left(-\beta \cdot \frac{n^2 h^2}{8mL^2}\right) \cong \int_1^{\infty} \exp\left(-\beta \cdot \frac{n^2 h^2}{8mL^2}\right) dn \cong \int_0^{\infty} \exp\left(-\beta \cdot \frac{n^2 h^2}{8mL^2}\right) dn = \frac{L}{\Lambda} \quad (\text{Eq.1.21})$$

and the characteristic length of the moving molecule given as

$$\Lambda = h \cdot \sqrt{\frac{\beta}{2\pi m}} \quad (\text{Eq.1.22})$$

Example 1.1.:

For example, we calculate the partition function of translational energy levels for hydrogen molecules (H_2) in the gas state at room temperature, enclosed within a vessel of volume $V = a^3 = 0.001 \text{ m}^3$:

$$\Lambda = h \cdot \sqrt{\frac{\beta}{2\pi m}} = 6.626 \cdot 10^{-34} \cdot \sqrt{\frac{1/(1.38 \cdot 10^{-23} \cdot 298)}{2\pi \cdot 0.002/6.02 \cdot 10^{23}}} \text{ m} = 7.15 \cdot 10^{-11} \text{ m}$$

Therefore:

$$q_{tr} = \frac{a^3}{\Lambda^3} = \left(\frac{0.1}{7.15 \cdot 10^{-11}}\right)^3 = 2.74 \cdot 10^{27}$$

Note that this very large number is consistent with the narrow energy spacing for our particle in a box problem: in the given energetic range of thermal energy $k_B \cdot T$ we have nearly a continuous spectrum of different levels of translational energy E_n .

B) Partition function of rotational energy levels:

Similar to the partition function of translational energy levels, for the rotational energy levels we can also substitute the sum by an integral, since again the energy differences, $\Delta E = E_{J+1} - E_J$, are extremely small in comparison to the range of thermal energies $k_B \cdot T$ typically considered.

$$\begin{aligned} q_{rot} &= \sum_{J=0}^{\infty} (2J+1) \cdot \exp(-hcBJ \cdot (J+1) \cdot \beta) \cong \int_0^{\infty} (2J+1) \cdot \exp(-hcBJ \cdot (J+1) \cdot \beta) dJ \\ &= -\frac{1}{hcB \cdot \beta} \cdot [\exp(-hcBJ \cdot (J+1) \cdot \beta)]_{J=0}^{J=\infty} = \frac{1}{hcB \cdot \beta} \end{aligned} \quad (\text{Eq.1.23})$$

Note that for symmetric molecules, like for example H_2 , this expression reduces to:

$$q_{rot} = \frac{1}{2} \cdot \frac{1}{hcB \cdot \beta} \quad (\text{Eq.1.24})$$

Example 1.2:

For example, we calculate the partition function of rotational energy levels for chlorine molecules (Cl_2) in the gas state at room temperature, using a bond length of chlorine molecules of 199 pm:

First, we calculate the momentum of inertia and the rotational constant:

$$I = 2 \cdot \left(\frac{0.0355}{6.02 \cdot 10^{23}} \cdot \left(\frac{199 \cdot 10^{-12}}{2} \right)^2 \right) = 1.17 \cdot 10^{-45} \text{ kg} \cdot \text{m}^2$$

$$B = \frac{h}{8\pi^2 c I} = \frac{6.626 \cdot 10^{-34}}{8 \cdot 3.14^2 \cdot 3 \cdot 10^8 \cdot 1.17 \cdot 10^{-45}} = 23.9 \text{ m}^{-1}$$

Therefore:

$$q_{rot} = \frac{1}{2} \cdot \frac{1}{hcB \cdot \beta} = \frac{1}{2} \cdot \frac{1.38 \cdot 10^{-23} \cdot 298}{6.626 \cdot 10^{-34} \cdot 3 \cdot 10^8 \cdot 23.9} = 432.8$$

Note that again this comparatively large number is consistent with the narrow energy spacing: in the given energetic range of thermal energy $k_B \cdot T$ we have nearly a continuous spectrum of different rotational energy levels E_J .

C) Partition function of vibrational energy levels (harmonic oscillator):

Typically, the energy spacing between oscillatory eigenvalues is large compared to the thermal energy $k_B \cdot T$. Therefore, this time we cannot replace the summation by an integral, but instead can apply the geometric series criterion:

$$\begin{aligned} q_{vib} &= \sum_{v=0}^{\infty} \exp(-\beta \cdot h \cdot \nu_0 \cdot (v + 1/2)) \\ &= \exp(-\beta \cdot h \cdot \nu_0 \cdot 1/2) \cdot \sum_{v=0}^{\infty} \exp(-\beta \cdot h \cdot \nu_0 \cdot v) = \frac{\exp(-\beta \cdot h \cdot \nu_0 \cdot 1/2)}{1 - \exp(-\beta \cdot h \cdot \nu_0)} \quad (\text{Eq.1.25}) \end{aligned}$$

since $h \cdot \nu_0 \gg k_B \cdot T$, $\exp(-\beta \cdot h \cdot \nu_0) \ll 1$, and therefore

$$\sum_{v=0}^{\infty} \exp(-\beta \cdot h \cdot \nu_0 \cdot v) = 1 + \exp(-\beta \cdot h \cdot \nu_0) + [\exp(-\beta \cdot h \cdot \nu_0)]^2 + \dots = \frac{1}{1 - \exp(-\beta \cdot h \cdot \nu_0)} \quad (\text{Eq.1.26})$$

Often, molecular vibrations can be excited with IR-light (for exceptions see selection rules of optical excitation spectroscopy, chapter 2 of this book), corresponding to wavelengths of several 1000 nm.

Example 1.3.:

For example, we calculate the partition function of vibrational energy levels for arbitrary molecules in the gas state which absorb IR-light of wavelength 3000 nm:

First, we calculate the oscillation frequency:

$$\nu_0 = \frac{c}{\lambda} = \frac{3 \cdot 10^8}{3000 \cdot 10^{-9}} = 10^{14} \text{ s}^{-1}$$

Therefore:

$$q_{vib} = \frac{\exp(-\beta \cdot h \cdot \nu_0 \cdot 1/2)}{1 - \exp(-\beta \cdot h \cdot \nu_0)} = \frac{\exp\left(-\frac{6.626 \cdot 10^{-34} \cdot 1/2 \cdot 10^{14}}{1.38 \cdot 10^{-23} \cdot 298}\right)}{1 - \exp\left(-\frac{6.626 \cdot 10^{-34} \cdot 10^{14}}{1.38 \cdot 10^{-23} \cdot 298}\right)} = 0.000317 < 1$$

Finally, let us try to interpret this result: even at zero temperature, the vibrational energy is non-zero due to the finite energy of the vibrational ground state, and therefore it is difficult to interpret the partition function directly. To determine the relative population of the first excited state, we therefore calculate the ratio

$$\begin{aligned} \frac{N_2}{N_1} &= \exp(-\beta \cdot (E_2 - E_1)) = \exp(-\beta \cdot h \cdot \nu_0) = \exp\left(-\frac{6.626 \cdot 10^{-34} \cdot 10^{14}}{1.38 \cdot 10^{-23} \cdot 298}\right) = \\ &= 1.01 \cdot 10^{-7} \end{aligned}$$

This means that the probability to populate the first excited state is about 0.1 ppm (parts per million) in respect to the population of the ground state.

1.3 The molecular partition function and macroscopic thermodynamic properties

In this section, I will show how the partition function is related to macroscopic, i.e. classical phenomenological thermodynamics. We start with the internal energy, which is identified as the overall energy of the system. Note that this assumption provides the basis for the relations between the variables of statistical thermodynamics (q , β) and the variables of classical phenomenological thermodynamics (U , T , ...). The validity of this assumption and its consequences on quantitative relations concerning fundamental thermodynamic properties, like for example the temperature dependence of heat capacities (see below), in practice had to be confirmed by experimental results.

$$\begin{aligned} U = E &= \sum N_i E_i = \\ &= \frac{N}{q} \cdot \sum E_i \cdot \exp(-\beta E_i) = \frac{N}{q} \cdot \sum -\frac{d}{d\beta} \exp(-\beta E_i) = -\frac{N}{q} \cdot \frac{d}{d\beta} \sum \exp(-\beta E_i) \quad (\text{Eq.1.27}) \end{aligned}$$

or

$$U = -\frac{N}{q} \cdot \frac{dq}{d\beta} = -N \cdot \frac{d \ln q}{d\beta} \quad (\text{Eq.1.28})$$

Note that our assumption for the derivation of the Boltzmann distribution was that all energy levels remain constant, corresponding to a constant volume of the system. Therefore, more accurately

$$U = -N \cdot \left(\frac{\partial \ln q}{\partial \beta} \right)_V \quad (\text{Eq.1.29})$$

Alternatively, using $\beta = (k_B T)^{-1}$, we can rewrite this equation as:

$$U = N \cdot k_B T^2 \cdot \left(\frac{\partial \ln q}{\partial T} \right)_V \quad (\text{Eq.1.30})$$

The overall partition function of a system of N non-interacting distinguishable particles is related to the molecular partition function via:

$$Q = q^N \quad (\text{Eq.1.31})$$

Cynthia | AXA Graduate



AXA Global Graduate Program

Find out more and apply

redefining / standards AXA

And therefore:

$$U = k_B T^2 \cdot \left(\frac{\partial \ln Q}{\partial T} \right)_V \quad (\text{Eq.1.32})$$

Having obtained a relation between the partition function and the internal energy, we can easily derive expressions for other thermodynamic quantities from the mathematical relations defined in classical thermodynamics:

For example, the heat capacity at constant volume is given as

$$c_V = \left(\frac{\partial U}{\partial T} \right)_V = k_B T^2 \cdot \left(\frac{\partial^2 \ln Q}{\partial T^2} \right)_V + 2k_B T \cdot \left(\frac{\partial \ln Q}{\partial T} \right)_V \quad (\text{Eq.1.33})$$

This expression (and the subsequent ones) becomes much simpler if we use $\beta = (k_B T)^{-1}$ instead of temperature T as the variable. In this case, derivation by temperature T corresponds to:

$$\frac{\partial}{\partial T} = \frac{\partial}{\partial \beta} \cdot \frac{\partial \beta}{\partial T} = \frac{\partial}{\partial \beta} \cdot \left(-\frac{1}{k_B T^2} \right) = -\beta^2 k_B \cdot \frac{\partial}{\partial \beta} \quad (\text{Eq.1.34})$$

and therefore

$$c_V = -\beta^2 k_B \cdot \frac{\partial}{\partial \beta} \left(-\left(\frac{\partial \ln Q}{\partial \beta} \right)_V \right) = k_B \cdot \beta^2 \cdot \left(\frac{\partial^2 \ln Q}{\partial \beta^2} \right)_V \quad (\text{Eq.1.35})$$

Let us consider a few more examples, before we discuss this result for the heat capacity of gas molecules in more detail, using the different partition functions derived above from the quantum chemical models of molecular rotations or vibrations, respectively.

The free energy is given as

$$F = U - T \cdot S \quad (\text{Eq.1.36})$$

and the corresponding total differential expression is:

$$dF = -SdT - pdV \quad (\text{Eq.1.37})$$

And therefore

$$F - T \cdot \left(\frac{\partial F}{\partial T} \right)_V = F + \beta \cdot \frac{\partial}{\partial \beta} F = U = -\frac{\partial}{\partial \beta} \ln Q \quad (\text{Eq.1.38})$$

which corresponds to:

$$F = -\frac{1}{\beta} \cdot \ln Q \quad (\text{Eq.1.39})$$

as can easily be proven:

$$\frac{\partial}{\partial \beta} F = \frac{1}{\beta^2} \cdot \ln Q - \frac{1}{\beta} \cdot \frac{\partial}{\partial \beta} \ln Q \quad (\text{Eq.1.40})$$

Therefore, we finally get:

$$F + \beta \cdot \frac{\partial}{\partial \beta} F = -\frac{\partial}{\partial \beta} \ln Q \quad (\text{Eq.1.41})$$

To conclude, let us derive the statistical thermodynamic expression for the entropy. For this purpose, we use the following relation from classical thermodynamics:

$$F = U - T \cdot S \quad (\text{Eq.1.42})$$

I joined MITAS because
I wanted **real responsibility**

The Graduate Programme
for Engineers and Geoscientists
www.discovermitas.com



Month 16
I was a construction supervisor in the North Sea advising and helping foremen solve problems

Real work
International opportunities
Three work placements





or

$$S = \frac{U-F}{T} \quad (\text{Eq.1.43})$$

Therefore,

$$S = k_B \cdot \beta \cdot \left(-\frac{\partial}{\partial \beta} \ln Q + \frac{1}{\beta} \cdot \ln Q \right) = -k_B \cdot \beta \cdot \frac{\partial}{\partial \beta} \ln Q + k_B \cdot \ln Q \quad (\text{Eq.1.44})$$

or, replacing the variables β and T , using $\beta = (k_B T)^{-1}$:

$$S = k_B \cdot \left(\left(\frac{\partial \ln Q}{\partial \ln T} \right)_V + \ln Q \right) = \frac{U}{T} + k_B \cdot \ln Q \quad (\text{Eq.1.45})$$

Let us investigate how this seemingly complicated expression is related to the purely statistical definition of the entropy,

$$S = k \cdot \ln \Omega_{max} \quad (\text{Eq.1.46})$$

According to Boltzmann statistics,

$$\ln \Omega = N \cdot \ln N - \sum N_i \cdot \ln N_i \quad (\text{Eq.1.47})$$

with the partition function with highest probability given as:

$$\frac{N_i}{N} = \frac{\exp\left(-\frac{\varepsilon_i}{k_B T}\right)}{q} \quad (\text{Eq.1.48})$$

Inserting eqs. (1.47) and (1.48) in eq. (1.46), we get:

$$S = k \cdot \left[N \cdot \ln N - N \cdot \sum \left\{ \frac{\exp\left(-\frac{\varepsilon_i}{k_B T}\right)}{q} \cdot \ln \left(N \cdot \frac{\exp\left(-\frac{\varepsilon_i}{k_B T}\right)}{q} \right) \right\} \right] \quad (\text{Eq.1.50})$$

with

$$\ln \left(N \cdot \frac{\exp\left(-\frac{\varepsilon_i}{k_B T}\right)}{q} \right) = \ln N + \ln \exp\left(-\frac{\varepsilon_i}{k_B T}\right) - \ln q \quad (\text{Eq.1.51})$$

Eq.(1.50) therefore becomes

$$S = k \cdot \left[N \cdot \ln q + \frac{N}{k_B T} \cdot \sum \frac{\epsilon_i \cdot \exp\left(-\frac{\epsilon_i}{k_B T}\right)}{q} \right] = k \cdot N \cdot \ln q + \frac{U}{T} \tag{Eq.1.52}$$

Note that Eqs.(1.52) and (1.45) only are identical if $k = k_B$, and $Q = q^N$. These considerations therefore nicely confirm the relation between the molecular partition function q and the partition function of a system of N non-interacting distinguishable particles Q (see above, Eq. (1.31)).

1.4 Heat capacities of gases, and characteristic temperatures

Let us apply our results to get a deeper understanding how the heat capacities of gases depend on temperature. In classical thermodynamics, we have no clue why not all microscopic degrees of freedom of a given gas molecule, translation, rotation and vibration, are thermally excitable at low temperatures. Phenomenologically (see, for example, W. Schärfl, bookboon: “Physical Chemistry – A complete introduction on bachelor of science level”) one obtains, for example via experimental observation, the typical behavior shown in figure 1.4.

ie business school

93%
OF MIM STUDENTS ARE
WORKING IN THEIR SECTOR 3 MONTHS
FOLLOWING GRADUATION

MASTER IN MANAGEMENT

- STUDY IN THE CENTER OF MADRID AND TAKE ADVANTAGE OF THE UNIQUE OPPORTUNITIES THAT THE CAPITAL OF SPAIN OFFERS
- PROPEL YOUR EDUCATION BY EARNING A DOUBLE DEGREE THAT BEST SUITS YOUR PROFESSIONAL GOALS
- STUDY A SEMESTER ABROAD AND BECOME A GLOBAL CITIZEN WITH THE BEYOND BORDERS EXPERIENCE

Length: 10 MONTHS
Av. Experience: 1 YEAR
Language: ENGLISH / SPANISH
Format: FULL-TIME
Intakes: SEPT / FEB

5 SPECIALIZATIONS
PERSONALIZE YOUR PROGRAM

#10 WORLDWIDE
MASTER IN MANAGEMENT
FINANCIAL TIMES

55 NATIONALITIES
IN CLASS

www.ie.edu/master-management | mim.admissions@ie.edu | [f](#) [t](#) [in](#) Follow us on IE MIM Experience



Heat capacities predicted by the simple model using molecular degrees of freedom only (translation, rotation, vibration) are limiting values reached at high sample temperature. For example, the molecules of the gas CO_2 have a total of $3N = 9$ degrees of freedom ($N =$ number of atoms constituting the molecule), which are allocated as following: 3 degrees of translation (directions x , y and z), 2 degrees of rotation (the rotational axis along the principle axis of the molecule in case of CO_2 has no momentum of inertia, and therefore the linear molecule has only 2 degrees of rotation), and finally $9 - 5 = 4$ degrees of vibration, leading to a total molar heat capacity of $3 \times 0.5R + 2 \times 0.5R + 4 \times R = 6.5R$ ($R =$ ideal gas constant, $8.314 \text{ J}/(\text{mole K})$). This simple theoretical concept, however, proves wrong in practice: to excite the vibrational degrees of freedom, you need a certain sample temperature of typically much more than 1000 K for biatomic molecules (see characteristic temperatures of vibration below). Rotation is more easily excited already at room temperature whereas translational motion is practically “for free”, i.e. the 3 translational degrees of freedom are excited already at the evaporation temperature irrespective of its value. As a consequence, the heat capacity of the gas increases stepwise as a function of temperature, and the position of the steps, or characteristic excitation temperatures, depend on specific molecular parameters such as mass of atoms, bond lengths and bond strengths, as will be shown now in more detail:

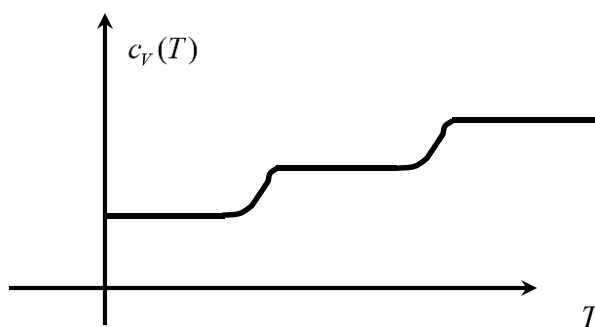

Fig.1.4.: T-dependence of the heat capacity of gases, based on molecular degrees of freedom

With the help of statistical thermodynamics, we can calculate the transition temperatures at which different degrees of freedom will be thermally excited, using the expression for the heat capacity $c_V(T)$ as a function of the respective partition functions of translation, rotation or vibration, and the corresponding molecular parameters such as atomic masses, bond lengths or bond strengths.

Let us first start with molecular vibrations. The molecular partition function based on the quantum mechanical solution of the harmonic oscillator is given as:

$$q_{vib} = \frac{\exp(-\beta \cdot h \cdot \nu_0 \cdot 1/2)}{1 - \exp(-\beta \cdot h \cdot \nu_0)} \quad (\text{Eq.1.53})$$

with

$$c_V = k_B \cdot \beta^2 \cdot \left(\frac{\partial^2 \ln Q}{\partial \beta^2} \right)_V \quad (\text{Eq.1.54})$$

One finally gets for the temperature dependence of the molar heat capacity, considering 1 degree of freedom of vibration only:

$$c_V = R \cdot \left\{ \frac{\left(\frac{\theta_{vib}}{T}\right) \exp\left(\frac{\theta_{vib}}{2T}\right)}{\exp\left(\frac{\theta_{vib}}{T}\right) - 1} \right\} \quad (\text{Eq.1.55})$$

with the characteristic transition temperature given as:

$$\theta_{vib} = \frac{\varepsilon}{k_B} = \frac{hc\tilde{\nu}_0}{k_B} = \frac{h\nu_0}{k_B} \quad (\text{Eq.1.56})$$

Here, $\tilde{\nu}_0$ is the wavenumber, and ν_0 the characteristic oscillation frequency, corresponding to the excitation energy of the vibration.

An analogous treatment for the molecular rotation yields a characteristic transition temperature

$$\theta_{rot} = \frac{\varepsilon}{k_B} = \frac{hcB}{k_B} \quad (\text{Eq.1.57})$$

“I studied English for 16 years but...
...I finally learned to speak it in just six lessons”
Jane, Chinese architect

ENGLISH OUT THERE

Click to hear me talking before and after my unique course download

Table 1.1 gives an overview of the characteristic transition temperatures of vibration and rotation, respectively, for some typical bimolecular gases:

gas	$\theta_{rot/K}$	$\theta_{vib/K}$
H ₂	85.4	5755
HCl	15.2	4140
O ₂	2.06	2230
Cl ₂	0.35	810
I ₂	0.054	310

Tab.1.1.: Characteristic transition temperatures for the excitation of molecular rotations and vibrations of common bimolecular gases

The transition temperature for the excitation of molecular rotations depends on the rotation constant B or momentum of inertia, and therefore atomic masses and bond lengths, whereas the transition temperature for excitation of vibrations depends on the characteristic oscillation frequency, or on atomic masses and bond strengths (see Eqs. (1.57), (1.56), and section 1.2). Therefore, hydrogen with by far the lightest atoms has the highest transition temperature both for rotation and vibration. If we compare HCl and H₂, reduced masses are differing by a factor of 2 only. We therefore would expect a vibration transition temperature difference by a factor of about 1.4 ($\sqrt{2}$). This is indeed the case, indicating also comparable bond strengths. On the other hand, comparing HCl and O₂ we have a difference in reduced masses of 1:8, whereas the transition temperatures differ by a factor of $2 = \sqrt{4}$. This indicates that the bond strength in O₂ is nearly twice that in HCl, in agreement with the double bond of O₂ molecules compared to the single bond of HCl molecules. Our examples illustrate how transition temperatures depend on molecular structure, or, vice versa, how conclusions concerning molecular parameters can be obtained from the experimentally determined transition temperatures.

Finally, it should be noted that the translational degrees of freedom have no transition temperature, but are fully excited already at very low temperatures. This is in agreement with the extremely large values of the corresponding molecular partition functions, showing the system has access to a large number of thermally excited states.

1.5 Statistical thermodynamics and chemical equilibrium

To conclude this chapter, I will demonstrate how the chemical equilibrium constant can be determined from molecular properties using the concept of statistical thermodynamics. In classical phenomenological thermodynamics, the equilibrium constant depends on the free enthalpy difference of products and educts, and therefore on an entropic and an enthalpic term, as:

$$\Delta_R G^* = \Delta_R H^* - T \cdot \Delta_R S^* = -R \cdot T \cdot \ln K_x \quad (\text{Eq.1.58})$$

Let us briefly recall here that in phenomenological thermodynamics it is already possible to calculate chemical equilibrium constants as absolute values. The corresponding thermodynamic quantities of the pure educts or products, like G^* , H^* or S^* , are set to zero for chemical elements at standard conditions ($T = 298 \text{ K}$, $p = 1 \text{ bar}$) as an arbitrary reference. For molecular chemical compounds, the respective values then are determined via the reaction quantities of the formation of these molecules from the corresponding elements. Non-standard conditions are considered by applying the respective quantitative relations from classical thermodynamics. Let us illustrate this concept with one example, the experimental determination of the absolute molar enthalpy of water at standard conditions:

The formation of water molecules from the corresponding elements is given by the well-known reaction



Arbitrarily, the enthalpies H^* of the elements H_2 and O_2 at standard conditions are set to zero. Note that these absolute values only serve as a reference, and have no consequence on the chemical equilibrium constant calculated using Eq.(1.58), since in this equation only differences of thermodynamic quantities of state are used. With this arbitrary assumption of reference states for thermodynamic quantities of state in classical thermodynamics, we finally get for our example, the formation of water molecules from the elements:

$$\Delta_R H^* = H^*(H_2O) - \frac{1}{2} \cdot H^*(H_2) - H^*(O_2) = H^*(H_2O) \quad (\text{Eq.1.60})$$

The reaction enthalpy $\Delta_R H^*$ can be measured by calorimetry at isobar conditions, i.e.

$$\Delta_R H^* = c_p \cdot \Delta T \quad (\text{Eq.1.61})$$

where the heat capacity of the reaction setup c_p is typically determined by calibration, i.e. heating the system by adding a defined amount of energy (for example by electric heating) and measuring the corresponding increase in temperature ΔT .

Statistical thermodynamics, in contrast to classical phenomenological thermodynamics, provides the connection between molecular parameters determined by quantum chemical calculations and/or spectroscopic measurements, and chemical equilibrium constants. The entropic term in Eq.(1.58) can be expressed by the partition functions of the product and educt species. For a simple chemical reaction of type $A \rightleftharpoons B$, the number of molecules assuming the educt or product states, respectively, is given directly by the Boltzmann probability, i.e.

$$N_A = \sum_i N_i^{(A)} = \frac{N}{q} \cdot \sum_i \exp(-\beta \cdot \varepsilon_i^{(A)}) = \frac{N}{q} \cdot q_A \quad (\text{Eq.1.62.1})$$

$$N_B = \sum_j N_j^{(B)} = \frac{N}{q} \cdot \sum_j \exp(-\beta \cdot (\varepsilon_j^{(B)} + \Delta E)) = \frac{N}{q} \cdot q_B \cdot \exp(-\beta \cdot \Delta E) \quad (\text{Eq.1.62.2})$$

with N the total number of molecules, q the partition function of the whole system consisting of educts and products, $N_i^{(A)}$ the number of educt molecules in the energetic state $\varepsilon_i^{(A)}$, and $N_j^{(B)}$ the number of product molecules in the energetic state $\varepsilon_j^{(B)}$. q_A and q_B are the molecular partition functions of educt and product species, respectively, at identical energy values of the respective ground states. For the occupation of states N_A, N_B , within our combined system, however, we have to consider that the energy levels of educts and products may start at different non-zero energy levels, $\varepsilon_0^{(B)} = \varepsilon_0^{(A)} + \Delta E$, with ΔE corresponding to the reaction energy (or reaction enthalpy at isobar conditions, and negligible change in reaction volume ($\Delta H = \Delta U + p \cdot \Delta V + V \cdot \Delta p$)). We finally get the following expression for the chemical equilibrium constant in the context of statistical thermodynamics:

$$K_N = \frac{N_B}{N_A} = \frac{q_B}{q_A} \cdot \exp(-(\varepsilon_0^{(B)} - \varepsilon_0^{(A)}) \cdot \beta) = \frac{q_B}{q_A} \cdot \exp(-\Delta E \cdot \beta) \quad (\text{Eq.1.63})$$

Note that this expression consists, like in classical phenomenological thermodynamics, of a purely entropic term containing the ratio of the respective partition functions of product and educt molecules, and an enthalpic term corresponding to the difference in energy between the ground states of products and educts, $\Delta E = \varepsilon_0^{(B)} - \varepsilon_0^{(A)}$.

Excellent Economics and Business programmes at:



university of
 groningen



“The perfect start
 of a successful,
 international career.”

CLICK HERE
 to discover why both socially
 and academically the University
 of Groningen is one of the best
 places for a student to be

www.rug.nl/feb/education

Graphically, this concept is interpreted as following:

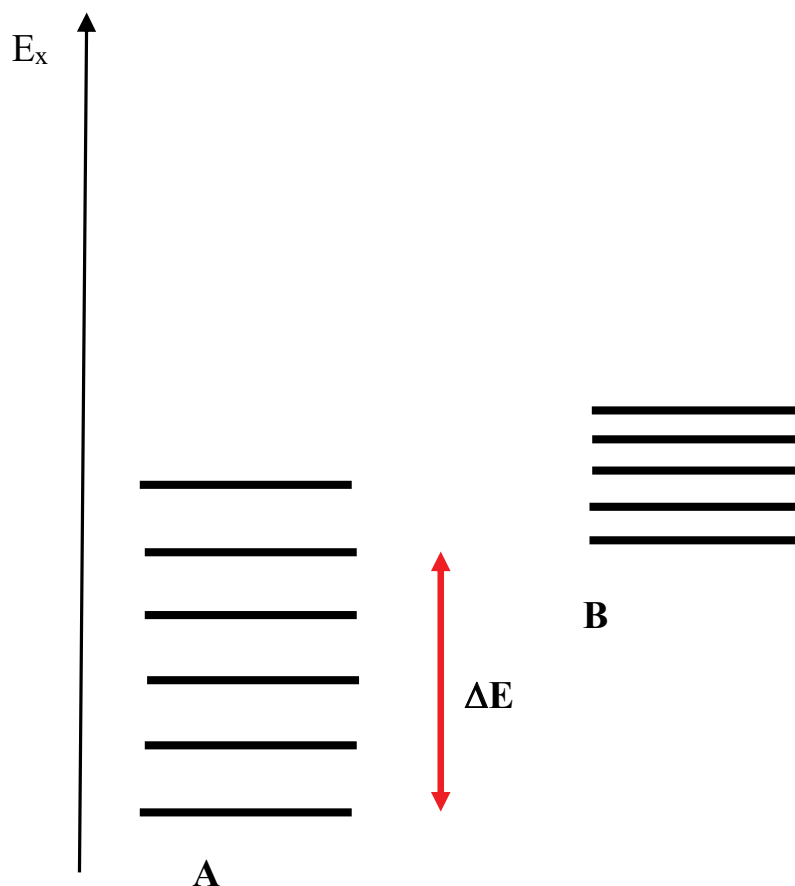

Figure 1.5.: Chemical equilibrium and its interpretation in statistical thermodynamics. Energetic states of educts (A) and products (B) have been chosen arbitrarily for an endothermic reaction, favored by reaction entropy.

Educts A and products B form a combined set of energetic states $\varepsilon_i^{(A)}$, $\varepsilon_j^{(B)}$, which are thermally populated according to the Boltzmann probability function. As shown in the figure, in case the energy spacing of states $\varepsilon_j^{(B)}$ is smaller than that of states $\varepsilon_i^{(A)}$, the partition function q_B would be larger than q_A , corresponding to a positive standard reaction entropy ($\Delta_R S^* > 0$). On the other hand, as also shown in this example, the energy spacing between the respective ground states is positive, i.e. $\Delta E = \Delta_R H^* > 0$, corresponding to an endothermic reaction. The chemical equilibrium constant, given by the ratio of particles occupying systems B and A, respectively, i.e. $K_N = N_B/N_A$, then is determined by the balance of standard reaction entropy and enthalpy $\Delta_R G^* = \Delta_R H^* - T \cdot \Delta_R S^*$, which in statistical thermodynamics is expressed by Eq. (1.63).

To illustrate this concept in a quantitative way, consider the following chemical equilibrium as a simple example:

Example 1.4:

Consider the chemical reaction $\text{Na}_2 \rightleftharpoons \text{Na} + \text{Na}$, i.e. the dissociation of Na_2 molecules in the gaseous phase, at $T = 1000 \text{ K}$. From spectroscopy (see chapter 2 of this book), the following molecular parameters could be determined:

Rotation constant $B = 0.1547 \text{ cm}^{-1}$, wave number of vibrational excitation of Na_2 $\tilde{\nu}_{\text{vib}} = 159.2 \text{ cm}^{-1}$, and dissociation energy of the Na_2 chemical bond $D_0 = 70.4 \text{ kJ/Mole}$.

The equilibrium constant is then given as:

$$K_N = \frac{(N_{\text{Na}})^2}{N_{\text{Na}_2}} = \frac{(q_{\text{Na}})^2}{q_{\text{Na}_2}} \cdot \exp\left(-\frac{D_0}{R \cdot T}\right)$$

The partition function of the Na atoms consist of the electronic and the translational part only, i.e.

$$q_{\text{Na}} = q_{\text{Na},tr} \cdot q_{\text{Na},el}$$

According to Eqs. (1.20) – (1.22), the translational part is given as:

$$q_{\text{Na},tr} = \frac{V}{(\Lambda_{\text{Na}})^3} = V \cdot 6.558 \cdot 10^{32}$$

The electronic ground state of Na atoms is a Doublet (one unpaired electron occupying the orbital of highest energy, twofold degenerate) therefore

$$q_{\text{Na},el} = 2$$

For the Na_2 molecules partition function, in addition the rotational and vibrational parts have to be taken into account:

$$q_{\text{Na}_2} = q_{\text{Na}_2,tr} \cdot q_{\text{Na}_2,el} \cdot q_{\text{Na}_2,rot} \cdot q_{\text{Na}_2,vib}$$

Analogous to the solutions for the Na atom, we get for the first two partition functions:

$$q_{\text{Na}_2,tr} = \frac{V}{(\Lambda_{\text{Na}_2})^3} = V \cdot 1.853 \cdot 10^{33}$$

And, since the electronic ground state of the Na_2 molecule is a Singlet (2 paired electrons occupying the orbital of highest energy):

$$q_{\text{Na}_2,el} = 1$$

Example 1.4, continued:

For the two remaining partition functions, we use the approximations derived above, i.e.

$$q_{Na_2,rot} = \frac{1}{2} \cdot \frac{k_B \cdot T}{h \cdot c} \cdot \frac{1}{B} = 2244$$

$$q_{Na_2,vib} = \frac{\exp\left(-\frac{h \cdot c \cdot \tilde{\nu}_{vib}}{2 \cdot k_B \cdot T}\right)}{1 - \exp\left(-\frac{h \cdot c \cdot \tilde{\nu}_{vib}}{k_B \cdot T}\right)} = 4.344$$

Inserting all these numbers into the expression for K_N , we finally get:

$$K_N = 2.00 \cdot 10^{25} \cdot V, \text{ or } K_N = 33.2 \frac{\text{Mole}}{L} \cdot V$$

Finally, it should be mentioned that there exist other statistical models besides the Boltzmann formalism. Since this booklet is mainly interested in illustrating the principle concepts of statistical thermodynamics, in this chapter I have restricted myself to the Boltzmann statistics only. Strictly spoken, this approach is limited to classical “distinguishable” particles. Quantum particles are “indistinguishable”, that is to say they cannot be distinguished by attaching numbers to them. Willard Gibbs has developed a different formalism by introducing so called statistical “ensembles” which allow treating systems of interacting particles (real gases, liquids, solids). Here it is also possible to handle the “indistinguishability” of particles in quantum gases. For the ideal gas, the partition functions should be calculated by using the Bose-Einstein-statistics, a model assuming a large number of non-interacting particles which are indistinguishable. However, it can be shown that at the large temperatures assumed for ideal gases the quantum expression for the partition function becomes identical with that of classical Boltzmann statistics, since the total number of energetic states by far exceeds the number of molecules (see, for example, the large value of the partition function of translation for simple molecules calculated above).

Another statistics is the Fermi-Dirac statistics, which explicitly takes into account the Pauli principle that each energetic state can only be occupied by one particle. This statistics is especially important if one would like to calculate the properties of electrons. Note that the result of the Fermi-Dirac partition function again is identical to that of the Boltzmann formalism in case of “large temperatures” where the total number of thermally accessible energetic states is much larger than the number of particles. This is the case for molecules, but not for electrons with their much lower mass.

For a more detailed discussion of these aspects of statistical thermodynamics, which is beyond the intentional scope of this booklet, the interested reader is referred to textbooks of Physical Chemistry.

2 Optical spectroscopy

In the 2nd part of this book, I will present the quantum chemistry treatment of optical spectroscopy. After a brief repetition of complex numbers needed to understand the following mathematics, and a section about the qualitative principles of optical spectroscopy, the third section will provide an introduction into quantum chemical perturbation theory. This theoretical part will be followed by the discussion of some of the most important fundamental optical spectroscopic methods.

2.1 Mathematical background – complex numbers

Before we introduce the mathematical/quantum chemical formalism of optical excitation spectroscopy, I feel it is necessary to introduce/repeat the principles of complex numbers. The basis of this concept is the definition of the imaginary unit:

$$i = \sqrt{-1} \quad (\text{Eq.2.1})$$



American online
LIGS University
is currently enrolling in the
Interactive Online **BBA, MBA, MSc,**
DBA and PhD programs:

- ▶ enroll **by September 30th, 2014** and
- ▶ **save up to 16%** on the tuition!
- ▶ pay in 10 installments / 2 years
- ▶ Interactive Online education
- ▶ visit www.ligsuniversity.com to find out more!

Note: LIGS University is not accredited by any nationally recognized accrediting agency listed by the US Secretary of Education. More info [here](#).



Whereas real numbers can be visualized in a one-dimensional coordinate system, complex numbers of type $A + B \cdot i$ (A, B being arbitrary real numbers) afford a two-dimensional coordinate system (xy -plane), where the real part of the number is associated with the x -axis, and the imaginary part B is associated with the y -axis. In this picture, complex numbers correspond to two-dimensional vectors. The absolute value of a complex number, or length of the vector, then is given as:

$$A + B \cdot i \rightarrow |A + B \cdot i| = \sqrt{(A + B \cdot i) \cdot (A - B \cdot i)} = \sqrt{A^2 + B^2} \tag{Eq.2.2}$$

If we introduce the complex conjugate number, we can express the absolute value of a complex number alternatively as:

$$A + B \cdot i = Z, \quad A - B \cdot i = Z^* \rightarrow |A + B \cdot i| = \sqrt{Z \cdot Z^*} = |Z|^2 \tag{Eq.2.3}$$

Note that our complex number $A + B \cdot i$ can also be expressed as following:

$$Z = A + B \cdot i = |Z| \cdot e^{i \cdot \text{arg}(Z)} \tag{Eq.2.4}$$

where the argument of the complex number $\text{arg}(Z)$ corresponds to the angle the vector forms with the x -axis, as shown in figure 2.1. The real and the imaginary part of the complex number $Z = A + B \cdot i$ then are given by the following trigonometric relations:

$$A = |Z| \cdot \cos(\text{arg}(Z)) \tag{Eq.2.5.1}$$

$$B = |Z| \cdot \sin(\text{arg}(Z)) \tag{Eq.2.5.2}$$

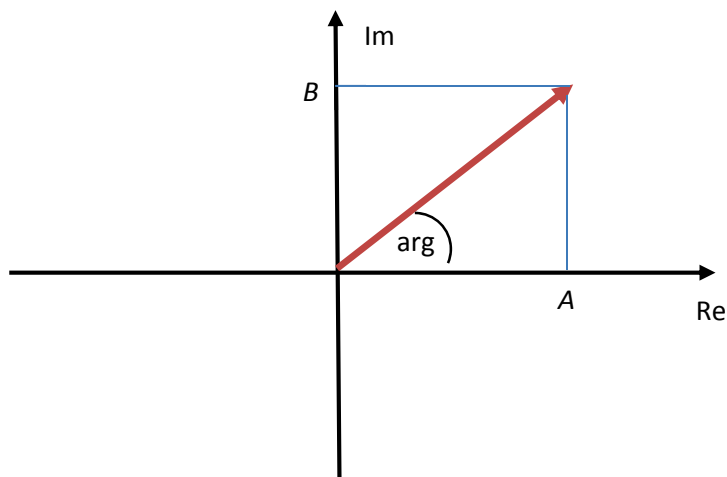

Figure 2.1: Complex number $Z = A + B \cdot i$ represented by a vector in 2d-number-space (in red), Re = axis of real part, Im = axis of imaginary part, arg = argument.

These expressions (see Eqs. (2.5)) lead us directly to the so-called Euler-equations, which make the solution of differential equations containing functions which, for example, are periodic in time, much easier, as will be seen in the next section.

$$e^{ix} = \cos x + i \cdot \sin x \tag{Eq.2.6.1}$$

$$e^{-ix} = \cos x - i \cdot \sin x \tag{Eq.2.6.2}$$

The concept of complex numbers is very important in science whenever we have a so-called phase-shift between two physical quantities which are periodic in time. For illustration, let us consider electric alternate voltage and electric alternate current (AC): in case of a constant electric current (DC), the relation between voltage and current is simply given by Ohm's law $U = R \cdot I$. In contrast, if we consider our daily alternate voltage system, the relation is more complicated: in this case, the resistance R can be represented by a complex number, and the input voltage as a cosine function of certain frequency (50 Hz in Europe, 60 Hz in the US). As a result of multiplying this cosine function with a complex number, the resulting current is a cosine function with the same frequency as the voltage but potentially shifted in phase between 0 and 90°, depending on the real part and the imaginary part of the complex resistance (also called impedance of the electrical circuit).

DON'T EAT YELLOW SNOW

What will your advice be?

Some advice just states the obvious. But to give the kind of advice that's going to make a real difference to your clients you've got to listen critically, dig beneath the surface, challenge assumptions and be credible and confident enough to make suggestions right from day one. At Grant Thornton you've got to be ready to kick start a career right at the heart of business.

Sound like you? Here's our advice: visit GrantThornton.ca/careers/students

Scan here to learn more about a career with Grant Thornton.

Grant Thornton
An instinct for growth™

© Grant Thornton LLP. A Canadian Member of Grant Thornton International Ltd



Let us consider this concept in more mathematical detail: within the plane of complex numbers, a function which is periodic in time, with a given frequency ν , can be defined as:

$$f(t) = e^{i2\pi\nu t} = e^{i\omega t} \quad (\text{Eq.2.7})$$

Here, ω is the angular velocity, directly related to the oscillation frequency as $\omega = 2\pi \cdot \nu$. One may visualize the function $f(t)$ as a unity vector in 2d-space of complex numbers, rotating counter-clockwise around the origin of the coordinate system. The argument of the complex number $\text{arg}(Z)$ then changes periodically with time, starting at 0° , corresponding to the vector lying at the x-axis at $t = 0$ (see figure 2.2.):

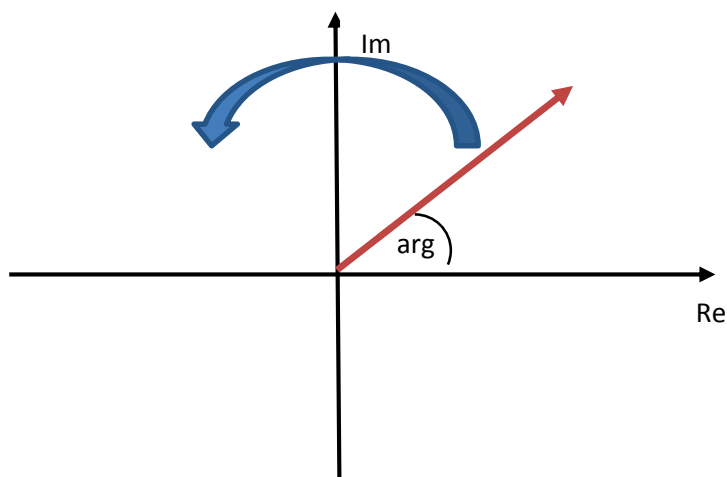

Figure 2.2: Periodically changing complex number represented by a vector in 2d-number-space (in red), turning counter-clockwise with time as indicated by the arrow.

According to the Euler equations, a simple cosine function, that is, a periodic function with no imaginary part, would then be given as:

$$\cos(\omega \cdot t) = \frac{1}{2} \cdot (e^{i\omega t} + e^{-i\omega t}) \quad (\text{Eq.2.8})$$

Within our picture of vectors rotating within the complex numbers plane with time, this would correspond to the addition of two unity vectors both starting at the x-axis, and then one rotating counter-clockwise, the other rotating clockwise with time, both having the same angular velocity ω . In this case, the imaginary parts of both vectors would cancel each other in all cases, whereas the real part would change from 1 to -1 periodically, with angular frequency ω , as expected for the simple cosine function.

Next, let us consider the multiplication of a complex quantity, changing periodically with time, with a complex number in mathematical detail. This problem corresponds exactly to the alternate voltage-alternate current circuit with complex resistance (or impedance) described above. In general, we can express a complex alternate current periodic in time as:

$$I = I_0 \cdot e^{i\omega t} \quad (\text{Eq.2.9})$$

with I_0 the amplitude or maximum current. The resulting voltage then depends on this current according to a generalized form of Ohm's law:

$$U = R \cdot I = |R| \cdot e^{i \arg(R)} \cdot I_0 \cdot e^{i\omega t} = |R| \cdot I_0 \cdot e^{i(\arg(R) + \omega t)} \quad (\text{Eq.2.10})$$

Mathematically, the voltage therefore corresponds to a vector in the complex number plane of length $|R| \cdot I_0$, starting at an angle $\arg(R)$ in respect to the x-axis (at $t = 0$), and rotating counter-clockwise around the origin with angular velocity ω . Therefore, the voltage is shifted in phase, compared to the electric alternate current, by $\arg(R)$, and we have shown that multiplying a function periodic in time with a complex number corresponds to a phase shift by the argument of the complex number.

Finally, another important example for the use of complex numbers in physics and materials science is mechanical spectroscopy: the sample is exposed to a periodic deformation, and the force necessary to achieve this deformation is measured as a function of time. If the sample is purely elastic (or solid), force and deformation will be in-phase, following Hook's law:

$$F = k \cdot x \quad (\text{Eq.2.11})$$

On the other hand, if the sample is a simple liquid, the force and deformation are shifted in phase by 90° , according to the Newton equation of viscosity:

$$F/A = \eta \cdot dv_x/dz = \eta \cdot v_x/d = \eta/d \cdot dx/dt. \quad (\text{Eq.2.12})$$

Here, A is the area of a thin liquid sample layer sheared in x-direction, and d is the total thickness of this liquid layer. dv_x/dz is the so-called shear rate, or velocity gradient of liquid layers perpendicular to the shear direction. The meaning of Eq.(2.12.) is, simply stated, that, if the deformation is given by a sine function in time, the corresponding force to achieve this periodic deformation then would be a cosine function in time with identical frequency as the deformation.

So called viscoelastic materials, which show both viscous and elastic behavior at the same time and therefore show deformation-force phase shifts between 0° and 90°, for example concentrated polymer solutions or polymer melts, are best described by a complex viscosity:

$$\eta^* = \eta' + i \cdot \eta'' \tag{Eq.2.12}$$

where η' corresponds to the elastic part or storage modulus (solid-like behavior, Hook’s law), and η'' corresponds to the viscous part or loss modulus (liquid-like behavior, Newton’s law). In this case, the so-called loss angle is defined as:

$$\tan \delta = \frac{\eta''}{\eta'} \tag{Eq.2.13}$$

The angle δ corresponds to the phase difference between the periodic deformation of the sample and the corresponding periodic force. For example, in case the elastic part and the viscous part of the sample are identical in value, force and deformation correspond to complex numbers periodically rotating around the origin of the complex numbers plane, with a phase difference of $\delta = 45^\circ$ between, i.e.:

$$x = x_0 \cdot \exp(i \cdot \omega \cdot t) \tag{Eq.2.14a}$$

$$F = F_0 \cdot \exp(i \cdot (\omega \cdot t + 45^\circ)) \tag{Eq.2.14b}$$

with x_0 the maximum deformation, and F_0 the amplitude of the oscillatory force.

.....Alcatel-Lucent 

www.alcatel-lucent.com/careers

What if you could build your future and create the future?

One generation’s transformation is the next’s status quo. In the near future, people may soon think it’s strange that devices ever had to be “plugged in.” To obtain that status, there needs to be “The Shift”.



Let us practice the calculation with complex numbers with a few examples:

Example 2.1:

Calculate the length and the argument in the 2d-plane of complex numbers for each of the following numbers, and sketch the numbers as vectors in the complex numbers plane:

- (i) $Z = 2 + 2 \cdot i$, (ii) $Z = 2 - 4 \cdot i$,
 (iii) $Z = -2 + 3 \cdot i$, (iv) $Z = -2 - 2 \cdot i$

Solutions:

$$Z = 2 + 2 \cdot i \Rightarrow |Z|^2 = Z \cdot Z^* = (2 + 2 \cdot i) \cdot (2 - 2 \cdot i) = 2^2 + 2^2 = 8$$

$$\arg(Z) = \operatorname{atan}\left(\frac{\operatorname{Im}(Z)}{\operatorname{Re}(Z)}\right) = \operatorname{atan}\left(\frac{2}{2}\right) = 45^\circ$$

$$Z = 2 - 4 \cdot i \Rightarrow |Z|^2 = Z \cdot Z^* = (2 - 4 \cdot i) \cdot (2 + 4 \cdot i) = 2^2 + 4^2 = 20$$

$$\arg(Z) = \operatorname{atan}\left(\frac{\operatorname{Im}(Z)}{\operatorname{Re}(Z)}\right) = \operatorname{atan}\left(\frac{-4}{2}\right) = -63^\circ$$

$$Z = -2 + 3 \cdot i \Rightarrow |Z|^2 = Z \cdot Z^* = (-2 + 3 \cdot i) \cdot (-2 - 3 \cdot i) = 2^2 + 3^2 = 13$$

$$\arg(Z) = \operatorname{atan}\left(\frac{\operatorname{Im}(Z)}{\operatorname{Re}(Z)}\right) = \operatorname{atan}\left(\frac{-3}{-2}\right) = -33.7^\circ / 146.3^\circ$$

$$Z = -2 - 2 \cdot i \Rightarrow |Z|^2 = Z \cdot Z^* = (-2 - 2 \cdot i) \cdot (-2 + 2 \cdot i) = 2^2 + 2^2 = 8$$

$$\arg(Z) = \operatorname{atan}\left(\frac{\operatorname{Im}(Z)}{\operatorname{Re}(Z)}\right) = \operatorname{atan}\left(\frac{-2}{-2}\right) = 45^\circ / 225^\circ$$

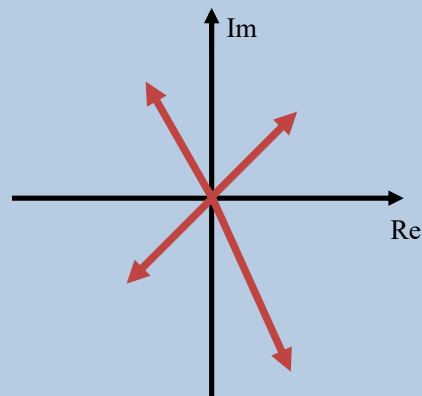

2.2 Principles of spectroscopy

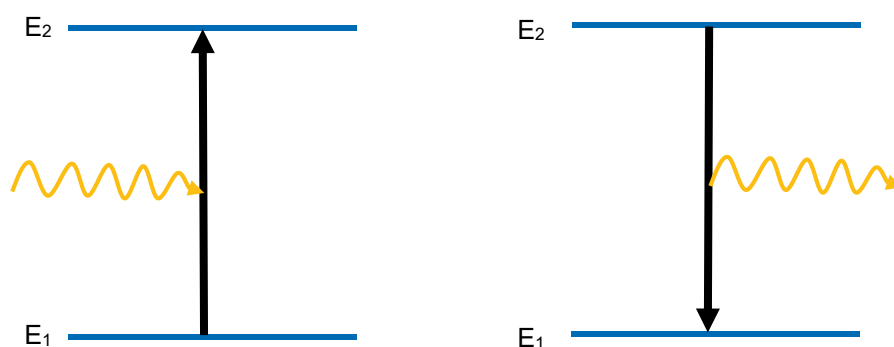

Figure 2.3.: Schematics of absorption (left) and emission (right) spectroscopy as energetic transitions between energy eigenvalues E_1 and E_2 , involving either absorption or emission of light of energy $\Delta E = E_2 - E_1 = h\nu = h\frac{c}{\lambda}$. See text for details.

Optical spectroscopy deals with the absorption or emission of electromagnetic radiation in connection with a transition between energetic states of atoms or molecules. Depending on wavelength and therefore energy of the radiation, one may address transitions between electronic states (UV/Vis), molecular vibrations and rotations (IR and microwaves, in case of molecules only), or magnetic states of the nucleus (radio waves). An optical absorption spectrum in terms of probability of light absorption in dependence of the wavelength of the incident light then directly depends on the energy eigenvalues and therefore is characteristic for a given molecule. Consequently, the spectrum may be used as a fingerprint in qualitative chemical analytics. For quantitative analytics, one can determine the absorption of light at given wavelength, and the concentration of a substance in solution is then given by the law of Lambert-Beer:

$$\log\left(\frac{I}{I_0}\right) = -\epsilon \cdot c \cdot d \quad (\text{Eq.2.15})$$

with I_0 the intensity of the incident light, I the intensity of the light passing an optical cuvette of thickness d , ϵ , the molar decadic extinction coefficient specific for a given molecule and wavelength of incident light, and the molar concentration of this molecule in solution.

As shown in fig.2.3, the energy of the electromagnetic radiation absorbed to trigger the transition between different energetic states of the molecule is given as:

$$\Delta E = E_2 - E_1 = h \cdot \nu = h \cdot \frac{c}{\lambda} = h \cdot c \cdot \tilde{\nu} \quad (\text{Eq.2.16})$$

with $h = 6.626 \cdot 10^{-34} \text{ J} \cdot \text{s}$ the Planck constant, ν the frequency, λ the wavelength, and $\tilde{\nu}$ the wave number of the incident radiation, which is often used as the characteristic parameter in optical spectra: in contrast to the wavelength λ , $\tilde{\nu}$ is directly proportional to the energy of the transition. $c = 3 \cdot 10^8 \text{ m/s}$ is the velocity of light in vacuum.

Wave lengths, wave numbers, energies and frequencies of electromagnetic waves are summarized in figure 2.4:

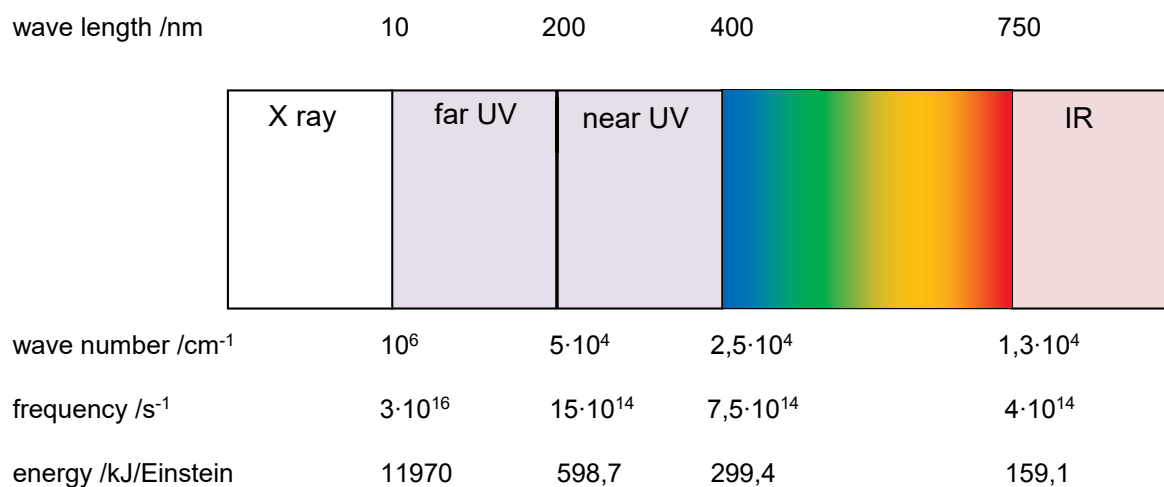

Figure 2.4.: wave lengths and energies of the electromagnetic spectrum (1 Einstein = 6.02e23 photons)

In table 2.1, some important spectroscopic methods, including the corresponding transition energies and the detected molecular properties, are summarized:

λ	ν	$\tilde{\nu}/\text{cm}^{-1}$	$\Delta E / \text{kJ/mol}$	molecular transition	method
100 m–1 m	3 MHz–300 MHz	10 ⁻⁴ –0.01	10 ⁻⁶ –10 ⁻⁴	nuclear spin	NMR
1 cm–100 μm	30 GHz–3·10 ¹² Hz	1–100	0,01–1	molecule rotation	microwave
100 μm –1 μm	3·10 ¹² Hz–3·10 ¹⁴ Hz	100–10 ⁴	1–100	molecule vibration	IR, Raman
1 μm –10 nm	3·10 ¹⁴ Hz–3·10 ¹⁶ Hz	10 ⁴ –10 ⁶	100–10 ⁴	outer (binding) electrons	UV/Vis, fluorescence

Table 2.1: some important spectroscopic methods

Next, let us consider some important principles of optical absorption spectroscopy in a qualitative way:

i) The Franck-Condon-principle: during an electronic transition of molecules, caused by absorption of UV/Vis-light, the positions of the atomic cores remain unchanged because of the short time scale or high frequency of the incident light ($\nu_0 \approx 10^{15} \text{ s}^{-1}$). Note that the excitation of an electron usually causes a decrease in strength of the chemical bond, and therefore the Morse potential (= potential of binding energy) of the excited electronic state in respect to that of the ground state is not only shifted to higher energy but also to larger interatomic distances or bond lengths (see fig.2.5). The probability of the electronic transition triggered by light absorption then is given, amongst others, by the overlap of the wave functions of the ground state and the excited state. The transition between electronic states of a molecule upon UV/Vis-absorption therefore usually is combined with the transition from a ground state of molecular vibrations to an excited vibrational state (lifetime $\tau \approx 10^{-12} \text{ s}$). This, in combination with a rapid radiation-less decay of the excited molecular vibrations, is the reason for the red shift of the emitted fluorescence light in respect to the wavelength of absorption (see fig.2.5).

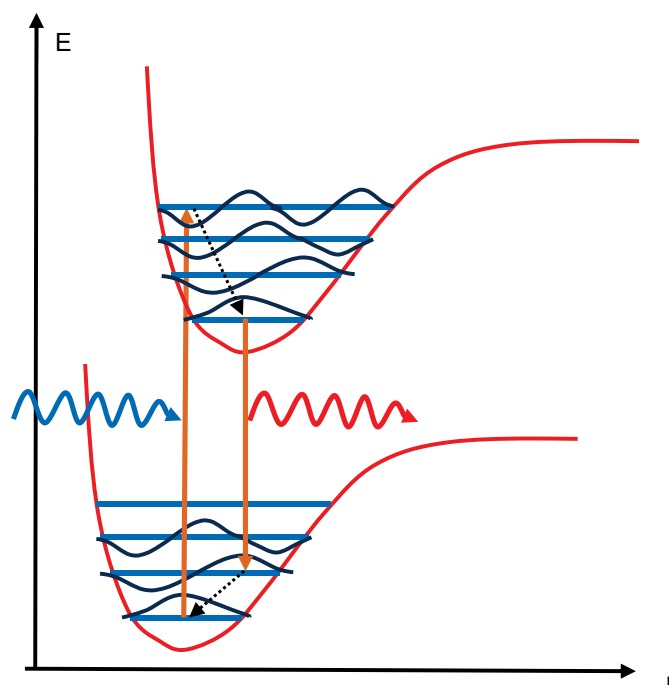

Figure 2.5.: electronic transition and the Franck-Condon principle ($E = \text{energy}$, $r = \text{interatomic distance or bond length}$): the transition has the largest probability at maximum overlap of the wave functions of the ground and the excited state. This, in combination with a rapid radiation-less decay of the molecules vibrations (dotted black arrows), explains why the emitted light (red) is shifted towards longer wave length (in respect to the absorbed light (blue)).

ii) For molecules, each electronic state corresponds to a given strength and length of the chemical bond and, correspondingly defines a Morse attraction potential of chemical binding. Each electronic energy level is, like a fractal system, divided into vibrational states, which themselves are further divided into rotational states:

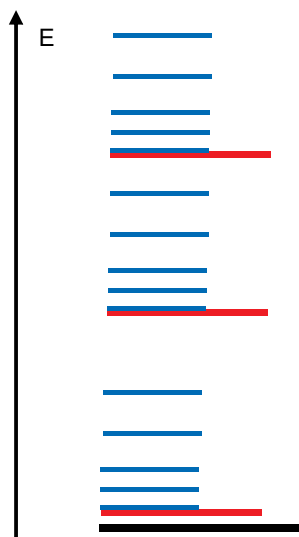

Figure 2.6.: "Fractal" energy levels: each electronic state (black) contains a set of vibrational states (red), which themselves contain a set of rotational states (blue).



Join the best at
the Maastricht University
School of Business and
Economics!

Top master's programmes

- 33rd place Financial Times worldwide ranking: MSc International Business
- 1st place: MSc International Business
- 1st place: MSc Financial Economics
- 2nd place: MSc Management of Learning
- 2nd place: MSc Economics
- 2nd place: MSc Econometrics and Operations Research
- 2nd place: MSc Global Supply Chain Management and Change

Sources: Keuzegids Master ranking 2013; Elsevier 'Beste Studies' ranking 2012; Financial Times Global Masters in Management ranking 2012

Maastricht University is the best specialist university in the Netherlands (Elsevier)

Visit us and find out why we are the best!
Master's Open Day: 22 February 2014

www.mastersopenday.nl



Whereas the transition between electronic states is triggered by the absorption of UV or visible light, the molecular vibrations within a given electronic state are addressed with radiation of much longer wavelength, IR, and the rotational states within a vibrational level are addressed with even longer wavelength radiation, microwaves. On the other hand, an electronic transition always contains a set of vibrational and rotational excitations, wherefore molecular UV/Vis-spectra, in contrast to the spectra of atoms, do not show sharp lines but characteristic broad absorption bands, if the absorption (see Eq.(2.15)) is plotted versus the wavelength of the incident light. Note that at high spectral resolution (which can be achieved for gases at low pressure and low temperature) the molecular absorption spectrum may consist of multiple absorption peaks, each with a very small spectral bandwidth (see below).

iii) Molecular transitions can only be triggered by the absorption of light if not only the wavelength is fitting to the energy difference between ground and excited state, but also if the electric dipole moment of the molecule is changing with the transition. This can be understood qualitatively if we consider that light is an electromagnetic wave, which energetically can only couple to a molecular transition via an interaction of its electric field vector with the dipole moment of the molecular transition (Fermi's golden rule, see next section). For example, the symmetric oscillation of a CO_2 -molecule cannot be detected by absorption of IR-light, since the dipole moment does not change for this mode of molecular vibration. On the other hand, the asymmetric vibration of the CO_2 -molecule can be detected by IR-absorption, since here the vibrational motion leads to a change of the dipole moment.

iv) So far, we have ignored the fact that in practice (and in contrast to Fig.2.3) the energy difference of the spectral transition is never exactly defined, and therefore all peaks in an optical excitation spectrum show a certain spectral bandwidth (see Figure 2.7):

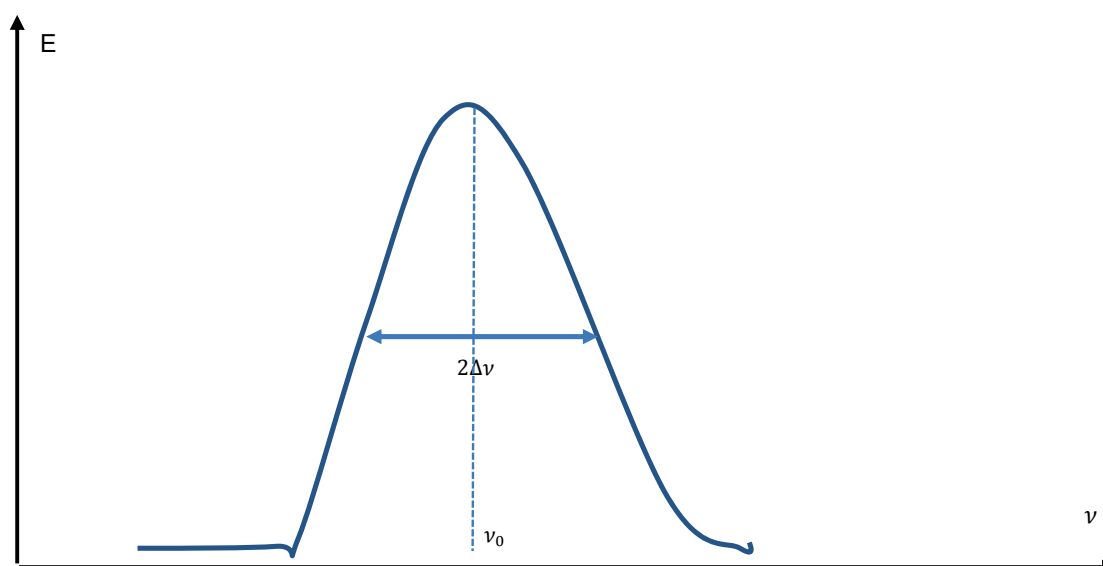

Figure 2.7.: Typical optical absorption peak, and spectral bandwidth FWHM (full width at half maximum), transition frequency $\nu = \nu_0 \pm \Delta\nu$

This bandwidth is depending on different physical contributions. The most important are:

- a) The natural bandwidth, given by the Heisenberg uncertainty principle as:

$$\Delta\nu \cdot \tau = \frac{1}{2\pi} \quad (\text{Eq.2.17})$$

with τ the lifetime of the excited state:

- b) The Doppler shift based on the Doppler effect. For gas molecules of mass m at temperature T , the corresponding spectral bandwidth is given as:

$$\Delta\nu = \nu_0 \cdot \frac{1}{c} \cdot \sqrt{\frac{8 \cdot k_B \cdot T}{m}} \cdot \ln 2 \quad (\text{Eq.2.18})$$

Here, the average velocity of the gas molecules, according to kinetic gas theory, is given as:

$$\langle u \rangle = \sqrt{\frac{8 \cdot k_B \cdot T}{\pi \cdot m}} \quad (\text{Eq.2.19})$$

$k_B \cdot T$ is the thermal energy per particle (see Chapter 1).

- c) Larger bandwidths due to molecular interactions/collisions



Empowering People. Improving Business.

BI Norwegian Business School is one of Europe's largest business schools welcoming more than 20,000 students. Our programmes provide a stimulating and multi-cultural learning environment with an international outlook ultimately providing students with professional skills to meet the increasing needs of businesses.

BI offers four different two-year, full-time Master of Science (MSc) programmes that are taught entirely in English and have been designed to provide professional skills to meet the increasing need of businesses. The MSc programmes provide a stimulating and multi-cultural learning environment to give you the best platform to launch into your career.

- MSc in Business
- MSc in Financial Economics
- MSc in Strategic Marketing Management
- MSc in Leadership and Organisational Psychology

BI NORWEGIAN BUSINESS SCHOOL

EFMD **EQUIS** ACCREDITED

www.bi.edu/master

For illustration, let us consider an absorption peak of hydrogen molecules in the gaseous state at room temperature:

Example 2.1:

Calculate the natural band width and the spectral Doppler shift of hydrogen molecules in the gaseous state at room temperature, assuming a transition wave length of 300 nm. The lifetime of the excited state is about 1 ns:

First, let us calculate the frequency of this transition:

$$\nu_0 = \frac{c}{\lambda} = \frac{3 \cdot 10^8 \frac{m}{s}}{300 \cdot 10^{-9} m} = 10^{15} s^{-1}$$

The respective spectral bandwidths are then given as:

(i) Natural bandwidth:

$$\Delta\nu = \frac{1}{2\pi \cdot \tau} = 1.6 \cdot 10^8 s^{-1}$$

(ii) Doppler shift:

$$\begin{aligned} \Delta\nu &= \nu_0 \cdot \frac{1}{c} \cdot \sqrt{\frac{8 \cdot k_B \cdot T}{m} \cdot \ln 2} = \\ &= 10^{15} s^{-1} \cdot \frac{1}{3 \cdot 10^8 \frac{m}{s}} \cdot \sqrt{\frac{8 \cdot 1.38 \cdot 10^{-23} \cdot 298}{0.002/6.0 \cdot 10^{23}} \cdot \ln 2} = \\ &= 8.7 \cdot 10^9 s^{-1} \end{aligned}$$

We note that the natural bandwidth is less than 1 ppm (part per million) of the transition energy, whereas the Doppler shift is in the order of 10 ppm.

Spectral bandwidths caused by intermolecular interactions or collisions are even much larger, and therefore optical spectra with high resolution can only be measured for gaseous samples at low temperature and low pressure. Note here that, in modern spectroscopy, even single molecules can be investigated using confocal optical techniques.

2.3 Quantum mechanical treatment of spectroscopy

For the mathematical treatment of optical spectroscopy, let us consider, for simplicity, a molecular system consisting of two energetically different quantum chemical states m , n only, and a transition between these states mediated by the absorption of light (electromagnetic radiation) (see fig. 2.8):

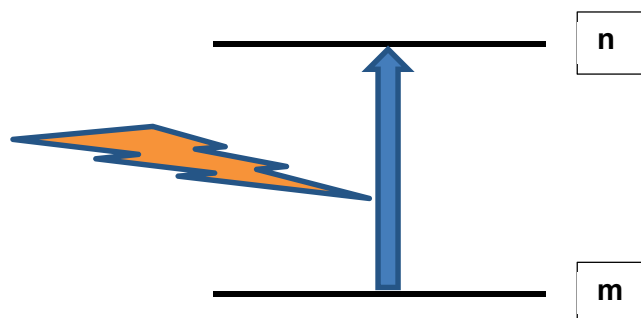

Figure 2.8.: Schematics of optical absorption spectroscopy for a two-state-system

The probability of this transition depends on the following conditions:

- i) The electrical dipole moment of the molecule has to change during the transition, because otherwise the electric field vector of the incident light cannot interact with the molecule and transfer energy.
- ii) The intensity of the transition is depending on the Boltzmann distribution – the larger the excess of molecules in the ground state before the transition, the more intense it is:

$$\frac{N_n}{N_m} = \exp \left[-\frac{E_n - E_m}{k_B T} \right] \quad , \quad N_n \ll N_m \quad (\text{Eq.2.20})$$

- iii) The energy of the incident radiation has to match the energy difference of the two states,

$$h \cdot \nu = E_n - E_m \quad (\text{Eq.2.21})$$

- iv) There are certain selection rules besides (i) and (iii) defining the principle possibility of any energetic transition which can be triggered by absorption of electromagnetic radiation.
- v) Finally, looking closely, the transition is energetically not as defined as one might deduce from the simple sketch (fig. 2.8), but in an optical spectrum the absorption peak even for atomic spectra has a finite bandwidth in energy, or frequency, $\Delta\nu$.

This last aspect (v) already has been addressed in detail at the end of the preceding section.

To derive a quantitative picture for optical absorption spectroscopy, we introduce the time dependent Schrödinger equation, combined with a simplified linear perturbation theory. The time-dependent Schrödinger equation is given as:

$$\hat{H}\psi(q, t) = i\hbar \cdot \frac{\partial\psi(q, t)}{\partial t} \quad (\text{Eq.2.22})$$

The general solution of this equation for the space- and time-dependent wave function, $\psi(q, t)$, can be separated into a time-independent part $f(q)$ - depending on the spatial coordinates (x, y, z), abbreviated simply as coordinate q – and a time-dependent part $\varphi(t)$:

$$\psi(q, t) = f(q) \cdot \varphi(t) \quad (\text{Eq.2.23})$$

This expression for the time-dependent wave function now is inserted into the Schrödinger equation, leading to:

$$\hat{H}(f(q) \cdot \varphi(t)) = i\hbar \cdot \frac{\partial(f(q) \cdot \varphi(t))}{\partial t} \quad (\text{Eq.2.24})$$

Separation of the variables q and t then yields

$$\frac{1}{f(q)} \cdot \hat{H}f(q) = \frac{1}{\varphi(t)} \cdot i\hbar \cdot \frac{\partial\varphi(t)}{\partial t} \quad (\text{Eq.2.25})$$

Since the left and right side of this equation depend on a different set of variables, each expression has to be constant to fulfill the relation. To start with, we define this constant as E , and will see immediately that it corresponds to the energetic eigenvalues of the stationary time-independent Schrödinger equation:

$$\hat{H}f(q) = E \cdot f(q) \quad (\text{Eq.2.26})$$

$$\frac{1}{\varphi(t)} \cdot i\hbar \cdot \frac{\partial\varphi(t)}{\partial t} = E \quad (\text{Eq.2.27})$$

Eq. (2.26) is exactly the stationary Schrödinger equation, and the time-independent part, $f(q)$, of our combined wave functions, $\psi(q, t) = f(q) \cdot \varphi(t)$, therefore directly correspond to the standard solutions. The 2nd expression (Eq.(2.27)) is a comparatively simple differential equation, leading to:

$$\varphi(t) = e^{-iEt/\hbar} \quad (\text{Eq.2.28})$$

Therefore, the general solution of the time-dependent Schrödinger equation is given as:

$$\psi(q, t) = f(q) \cdot e^{-iEt/\hbar} \quad (\text{Eq.2.29})$$

For our two-state system, we correspondingly obtain 2 different time-dependent wave functions as mathematical solutions, given as:

$$\psi_m(q, t) = f_m(q) \cdot e^{-iE_m t/\hbar} \quad (\text{Eq.2.30.1})$$

$$\psi_n(q, t) = f_n(q) \cdot e^{-iE_n t/\hbar} \quad (\text{Eq.2.30.2})$$

Note that the time dependence corresponds to a periodic oscillation, with frequencies $\nu_m = E_m/h$ or $\nu_n = E_n/h$, respectively. On the other hand, the linear combination of these 2 functions is also a solution of the time-dependent Schrödinger equation:

$$\psi(q, t) = c_m \cdot \psi_m(q, t) + c_n \cdot \psi_n(q, t) \quad (\text{Eq.2.31})$$

Here, the time-independent factors c_m and c_n are complex numbers with values between 0 and 1, designating the relative contribution of each wave function to the overall time-dependent combination.

Need help with your dissertation?

Get in-depth feedback & advice from experts in your topic area. Find out what you can do to improve the quality of your dissertation!

Get Help Now



Go to www.helpmyassignment.co.uk for more info



Helpmyassignment



Click on the ad to read more

So far, we have not yet considered the contribution of the incident electromagnetic wave to our quantum chemical system. For this purpose, we introduce the perturbation operator \hat{H}' , assuming that the perturbation is comparatively weak so it only triggers a molecular transition and does not change the energy levels of the unperturbed molecule themselves, i.e. $\hat{H}' \ll \hat{H}$. As a consequence, also the stationary wave functions $f(q)$ are unchanged compared to the non-perturbed case, and the transition is mathematically described only in terms of a change of the coefficients, $c_m(t)$, $c_n(t)$, with time.

Inserting the new combined Hamiltonian $\hat{H} + \hat{H}'$ into the time-dependent Schrödinger equation, and eliminating the terms corresponding to the unperturbed Schrödinger equation on both sides, then leads to:

$$\hat{H}'[c_m(t) \cdot \psi_m(q, t) + c_n(t) \cdot \psi_n(q, t)] = i\hbar \cdot \left[\psi_m(q, t) \cdot \frac{\partial c_m(t)}{\partial t} + \psi_n(q, t) \cdot \frac{\partial c_n(t)}{\partial t} \right] \quad (\text{Eq.2.32})$$

Let us assume that at time $t = 0$, the system is completely in the ground state, leading to the initial conditions for the differential equation $c_m(t) = 1$, and $c_n(t) = 0$. Inserting these initial conditions in the above equation, multiplying with the complex conjugate wave function $\psi_n^*(q, t)$, and integrating over the variable q , while considering that the wave functions have to be orthogonal and normalized, finally leads us to:

$$\frac{\partial c_n(t)}{\partial t} = \frac{1}{i\hbar} \cdot \int \psi_n^*(q, t) \cdot \hat{H}' \psi_m(q, t) dq \quad (\text{Eq.2.33})$$

This expression describes the initial rate with which the excited state will be occupied once the perturbation, in form of the incident electromagnetic wave, is switched on. As mentioned, here we have used the orthogonality and normalization criteria of quantum mechanical wave functions, given as:

$$\int \psi_n^*(q, t) \cdot \psi_m(q, t) dq = 0 \quad (\text{Eq.2.34.1})$$

$$\int \psi_n^*(q, t) \cdot \psi_n(q, t) dq = 1 \quad (\text{Eq.2.34.2})$$

To solve Eq. (2.33), we need a detailed mathematical formulation for the Hamiltonian of perturbation \hat{H}' . The interaction energy upon absorption of an electromagnetic wave is classically given by the electric field of the incident light multiplied with the dipole moment of the light absorbing molecule. Note that the electric field is a vector, and the dipole moment in the quantum chemical description becomes a vector operator, i.e.:

$$\hat{H}' = \vec{E} \cdot \vec{\mu} \quad (\text{Eq.2.35})$$

and

$$\vec{E} = \vec{E}_0 \cdot \cos(2\pi\nu t) = \frac{1}{2} \vec{E}_0 \cdot \{e^{2\pi i\nu t} + e^{-2\pi i\nu t}\} \quad (\text{Eq.2.36})$$

\vec{E}_0 is the amplitude vector of the electric field of the incident light, and ν is the frequency of the light. Here, we introduced the complex exponentials for the cosine according to the Euler expression to facilitate the solution of the differential equation (see Eqs. (2.6.) and (2.8.), above). Inserting the expression for the perturbation operator we therefore have to solve the following differential equation for $c_n(t)$:

$$\frac{\partial c_n(t)}{\partial t} = \frac{\vec{E}_0}{2i\hbar} \cdot \{e^{2\pi i\nu t} + e^{-2\pi i\nu t}\} \cdot \int \psi_n^*(q, t) \cdot \vec{\mu} \psi_m(q, t) dq \quad (\text{Eq.2.37})$$

with

$$\psi_n(q, t) = f_n(q) \cdot e^{-iE_n t/\hbar} \quad (\text{Eq.2.38})$$

To separate the time-independent part, we next introduce the transition electric dipole moment \vec{R}_{nm} defined as:

$$\vec{R}_{nm} = \int f_n^*(q) \cdot \vec{\mu} f_m(q) dq \quad (\text{Eq.2.39})$$

Multiplying the time-dependent complex exponential functions respectively then leads to:

$$\frac{\partial c_n(t)}{\partial t} = \frac{\vec{E}_0}{2i\hbar} \cdot \{e^{i(E_n - E_m + h\nu) \cdot t/\hbar} + e^{i(E_n - E_m - h\nu) \cdot t/\hbar}\} \cdot \vec{R}_{nm} \quad (\text{Eq.2.40})$$

This differential equation is quite easily solved because of the exponential function, and we finally get:

$$c_n(t) - c_n(0) = \frac{\vec{E}_0}{2i\hbar} \cdot \vec{R}_{nm} \cdot \int_0^t \{e^{i(E_n - E_m + h\nu) \cdot t/\hbar} + e^{i(E_n - E_m - h\nu) \cdot t/\hbar}\} dt = \frac{\vec{E}_0}{2i\hbar} \cdot \vec{R}_{nm} \cdot \left[\frac{\hbar}{i(E_n - E_m + h\nu)} \cdot e^{i(E_n - E_m + h\nu) \cdot t/\hbar} + \frac{\hbar}{i(E_n - E_m - h\nu)} \cdot e^{i(E_n - E_m - h\nu) \cdot t/\hbar} \right]_0^t \quad (\text{Eq.2.41})$$

If we also consider that, for resonance conditions, i.e. $E_n - E_m - h\nu = 0$, the first term in the brackets [...] in Eq. (2.41) can be neglected in respect to the 2nd term which becomes very large, we finally get:

$$c_n(t) = \frac{\vec{E}_0}{2} \cdot \left\{ \frac{1 - e^{i(E_n - E_m - h\nu) \cdot t/\hbar}}{E_n - E_m - h\nu} \right\} \cdot \vec{R}_{nm} \quad (\text{Eq.2.42})$$

This expression is a complex number. For practical interpretation, we therefore refer to its absolute value squared:

$$|c_n(t)|^2 = c_n^*(t) \cdot c_n(t) = \frac{\vec{E}_0^2}{4} \cdot \vec{R}_{nm}^2 \cdot \left\{ \frac{1 - e^{i(E_n - E_m - h\nu) \cdot t/\hbar}}{E_n - E_m - h\nu} \right\} \cdot \left\{ \frac{1 - e^{-i(E_n - E_m - h\nu) \cdot t/\hbar}}{E_n - E_m - h\nu} \right\} \quad (\text{Eq.2.43})$$

Using the Euler equations and the 3rd Binomial formula, this expression leads us to:

$$|c_n(t)|^2 = \frac{\vec{E}_0^2}{4} \cdot \vec{R}_{nm}^2 \cdot \frac{1}{(E_n - E_m - h\nu)^2} \cdot (2 - 2 \cdot \cos((E_n - E_m - h\nu) \cdot t/\hbar)) \quad (\text{Eq.2.44})$$

since:

$$\begin{aligned} & (1 - e^{i \cdot (E_n - E_m - h\nu) \cdot t/\hbar}) \cdot (1 - e^{-i \cdot (E_n - E_m - h\nu) \cdot t/\hbar}) = \\ & = (1 - \cos((E_n - E_m - h\nu) \cdot t/\hbar) - i \cdot \sin((E_n - E_m - h\nu) \cdot t/\hbar)) \\ & \quad \cdot (1 - \cos((E_n - E_m - h\nu) \cdot t/\hbar) + i \cdot \sin((E_n - E_m - h\nu) \cdot t/\hbar)) = \\ & = (1 - 2 \cdot \cos((E_n - E_m - h\nu) \cdot t/\hbar) + [\cos((E_n - E_m - h\nu) \cdot t/\hbar)]^2 + [\sin((E_n - E_m - h\nu) \cdot t/\hbar)]^2) \end{aligned} \quad (\text{Eq.2.45})$$

Next, we use the cosine addition theorem $(1 - \cos 2x) = 1 - \cos^2 x + \sin^2 x = 2 \cdot \sin^2 x$ to obtain:

$$|c_n(t)|^2 = \frac{\vec{E}_0^2}{4} \cdot \vec{R}_{nm}^2 \cdot \frac{4 \cdot \sin^2((E_n - E_m - h\nu) \cdot t/(2\hbar))}{(E_n - E_m - h\nu)^2} \quad (\text{Eq.2.46})$$

Finally, as the last step, we consider the fact that the radiation may contain multiple frequencies, i.e. is not strictly monochromatic, and therefore we have to integrate over the frequency spectrum of the incident light:

$$|c_n(t)|^2 = \frac{\vec{E}_0^2}{4} \cdot \vec{R}_{nm}^2 \cdot \int_{-\infty}^{\infty} \left\{ \frac{4 \cdot \sin^2((E_n - E_m - h\nu) \cdot t/(2\hbar))}{(E_n - E_m - h\nu)^2} \right\} d\nu \quad (\text{Eq.2.47})$$

Brain power

By 2020, wind could provide one-tenth of our planet's electricity needs. Already today, SKF's innovative know-how is crucial to running a large proportion of the world's wind turbines.

Up to 25 % of the generating costs relate to maintenance. These can be reduced dramatically thanks to our systems for on-line condition monitoring and automatic lubrication. We help make it more economical to create cleaner, cheaper energy out of thin air.

By sharing our experience, expertise, and creativity, industries can boost performance beyond expectations. Therefore we need the best employees who can meet this challenge!

The Power of Knowledge Engineering

Plug into The Power of Knowledge Engineering.
Visit us at www.skf.com/knowledge

SKF

This integral is more easily solved if we reformulate the integrand $\{\dots\}$ as:

$$|c_n(t)|^2 = \frac{\vec{E}_0^2}{4\hbar^2} \cdot \vec{R}_{nm}^2 \cdot \int_{-\infty}^{\infty} \left\{ \frac{\sin^2 \left[\frac{E_n - E_m - h\nu}{2\hbar} \cdot t \right] \cdot t^2}{\left(\frac{E_n - E_m - h\nu}{2\hbar} \cdot t \right)^2} \right\} d\nu \quad (\text{Eq.2.48})$$

or

$$|c_n(t)|^2 = \frac{\vec{E}_0^2}{4\hbar^2} \cdot \vec{R}_{nm}^2 \cdot t^2 \cdot \frac{2\hbar}{h \cdot t} \int_{-\infty}^{\infty} \left\{ \frac{\sin^2 x}{x^2} \right\} dx \quad (\text{Eq.2.49})$$

Here, we have used that the variable $x = \left[\frac{E_n - E_m - h\nu}{2\hbar} \cdot t \right]$ is introduced into the integrand via

$$dx = \left(\frac{dx}{d\nu} \right) d\nu = -\frac{h \cdot t}{2\hbar} d\nu \quad (\text{Eq.2.50})$$

With $\int_{-\infty}^{\infty} \left\{ \frac{\sin^2 x}{x^2} \right\} dx = \pi$, we end up with a fairly simple expression:

$$|c_n(t)|^2 = \frac{\vec{E}_0^2}{4\hbar^2} \cdot \vec{R}_{nm}^2 \cdot t \quad (\text{Eq.2.51})$$

This expression, a simplified form of Fermi's golden rule for the transition between two energetically well-defined quantum chemical levels, states, simply spoken, that the probability to find molecules in the excited state n after incident irradiation is depending on the following important factors:

- i) The electric field amplitude of the incident light squared, \vec{E}_0^2
- ii) The transition electric dipole moment squared, \vec{R}_{nm}^2
- iii) The duration of irradiation, t

Especially condition (ii) is responsible for the selection rules of spectroscopy and explains, for example, why the vibrations of homologous diatomic molecules, like Cl_2 , cannot be excited by the absorption of infrared light.

2.4 Optical spectroscopic methods

2.4.1 UV/Vis-absorption and emission, molecular electronic transitions

We conclude this section by reviewing the spectroscopic transitions between electronic states of molecules in more detail. The following scheme, called Jablonski-diagram, summarizes the possible transitions (see fig.2.9):

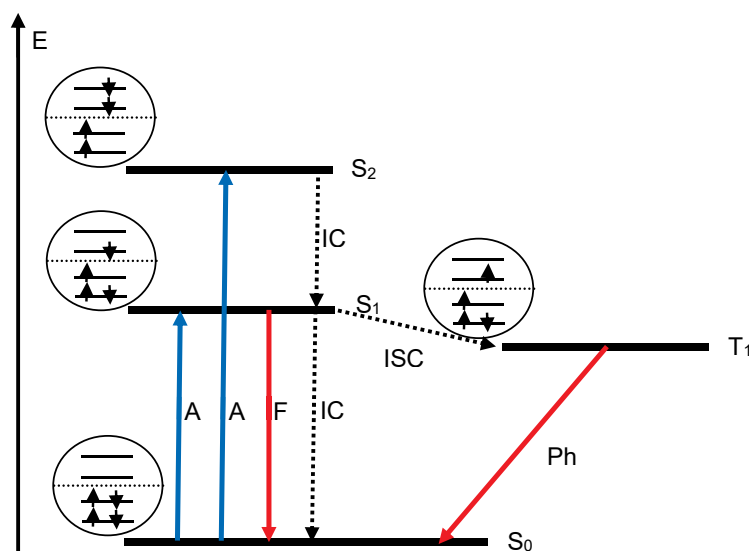

Figure 2.9.: Jablonski diagram showing electronic excitation and different pathways of energy relaxation (with and without (dotted) radiation absorption/emission). Circles indicate the electronic configuration of the respective electronic states, spins included. See text for details.

Upon UV/Vis-irradiation and absorption of light (A), the molecule shows an electronic transition from the ground state (in combination with the corresponding vibrational ground state, which, at room temperature, according to the Boltzmann distribution is the only vibrational state accessible by most molecules) S_0 to an excited electronic state S_1 or S_2 . Since this electronic excitation usually is combined with a reduction of the molecular bond strength, the average bond length will increase, leading to a maximum spectral overlap for the wave function of the vibrational ground state of S_0 with the wave function of an excited vibrational state of S_1 or S_2 (see also fig.2.5). For convenience, we have repeated figure 2.5 here again.

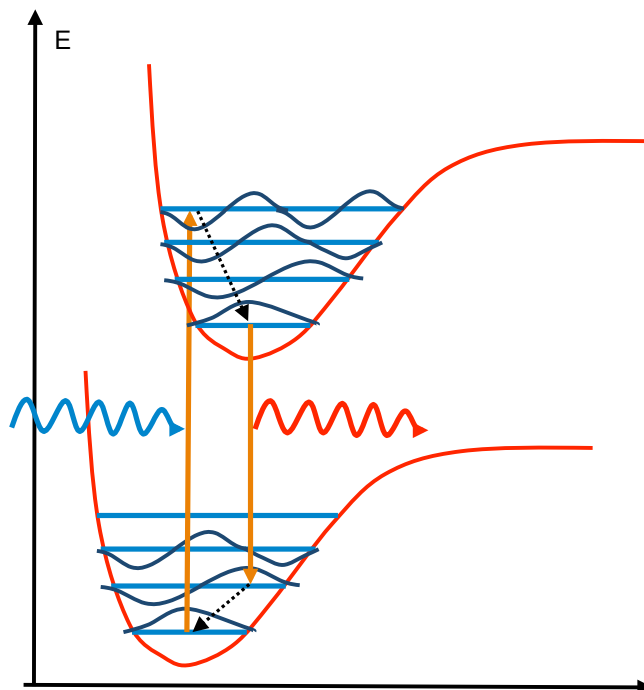

Figure 2.5.: electronic transition and the Franck-Condon principle ($E =$ energy, $r =$ interatomic distance or bond length): the transition has the largest probability at maximum overlap of the wave functions of the ground and the excited state. This, in combination with a rapid radiation-less decay of the molecules vibrations (dotted black arrows), explains why the emitted light (red) is shifted towards longer wave length (in respect to the absorbed light (blue)).

TURN TO THE EXPERTS FOR SUBSCRIPTION CONSULTANCY

Subscribe is one of the leading companies in Europe when it comes to innovation and business development within subscription businesses.

We innovate new subscription business models or improve existing ones. We do business reviews of existing subscription businesses and we develop acquisition and retention strategies.

Learn more at [linkedin.com/company/subscribe](https://www.linkedin.com/company/subscribe) or contact Managing Director Morten Suhr Hansen at mha@subscribe.dk

SUBSCRIB✓**BE** - to the future



Click on the ad to read more

Next, the excited energy is partially converted via a rapid radiation-less decay mechanism, called internal conversion (time-scale: 10^{-12} seconds) (IC), into heat, before radiation is emitted during the electronic energy transition from the vibrational ground state of S_1 to an excited vibrational state of S_0 (F). This emission called fluorescence, on a time-scale of $10^{-9} - 10^{-6}$ seconds, is therefore shifted, in respect to the wavelength of the incident light, towards longer wavelengths (red-shift).

Some molecules, especially those containing heavier atoms like sulfur (S) or phosphor (P), show a competing process, a transition from S_1 (singlet, total spin of electrons $S = 0$, with spin multiplicity $2S + 1 = 1$) to an excited triplet state T_1 (triplet, = two electrons with parallel spin, yielding a total electron spin of $S = 1$, with spin multiplicity $2S + 1 = 3$). For the exact definition of the spin, the interested reader is referred to any standard textbook of quantum chemistry. This singlet-triplet transition process, called intersystem crossing (ISC), is usually forbidden and therefore very slow, since it violates the physical principle of the conservation of the angular momentum. However, in case of heavier atoms, the change in the electron spin may be compensated by a corresponding change in the electrons angular momentum, a phenomenon called “spin-orbit-coupling”, which strongly accelerates the ISC to a time scale where it can compete with fluorescence (about 10^{-9} s). From the excited triplet state, the system decays via emission of radiation on a very slow time scale (1–100 s) which is called phosphorescence (Ph).

2.4.2 IR absorption – molecular vibration and rotation transitions

As an illustrative example how to extract molecular characteristics from an optical spectrum, let us consider the rotation-vibration spectrum of HCl in the gaseous state at low pressure and low temperature (= high spectral resolution and small spectral bandwidths). Only in this case, the energetic levels are well-defined to allow the separate detection of individual rotational levels within the vibrational excitation. At higher pressure, or even in the condensed phase, an increase of the spectral bandwidth, mostly due to intermolecular interactions and collisions, leads to a comparatively blurred broad absorption band with no spectral fine structure. The allowed transitions and the resulting spectrum are sketched in figure 2.10.

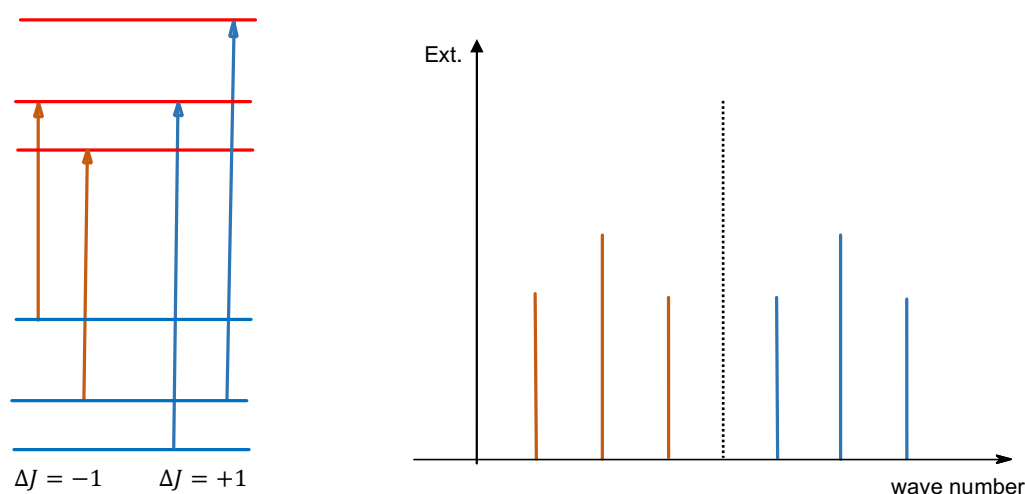

Figure 2.10.: Energy transitions (right) and corresponding rotational-vibrational spectrum of HCl (left). The dotted line corresponds to the hypothetical transition $\Delta J = 0$ not found in the HCl-spectrum. Note that here the phenomenon of rotation-vibration coupling has been ignored (see below)

The selection rules of allowed energetic transitions for the spectrum sketched in fig.2.10 are $\Delta v = +1$, i.e. vibrational excitation by one energy level, and $\Delta J = \pm 1$, i.e. rotational excitation with a change in rotational quantum number by ± 1 . Note that the selection rule $\Delta J = \pm 1$ is based on the conservation of the total angular momentum of rotation, a principle also known in classical physics: the photon has a rotational momentum or spin of 1, and therefore the loss of this spin upon light absorption has to be compensated by a corresponding change of the rotational state of the molecule.

These selection rules lead to a spectrum containing two series of peaks, one corresponding to $\Delta J = +1$ at higher wave number, and the other corresponding $\Delta J = -1$ to at lower wave number. The gap in between, formally corresponding to $\Delta J = 0$, reflects a hypothetical purely vibrational transition, and the corresponding wave number allows to directly extract the bond strength k using:

$$\tilde{\nu} = \frac{1}{\lambda} = \frac{\nu}{c} \quad , \quad \nu = \sqrt{\frac{k}{m}} \quad (\text{Eqs.2.52})$$

The mass of vibrating atoms at given bond strength may have a strong influence on the energy of the vibrational states, or the peak position in an IR-absorption spectrum. This effect of atomic mass on the vibrational energy is best illustrated by the IR- or Raman-spectra of organic molecules containing either hydrogen or deuterium. The doubling in mass has a correspondingly strong isotope effect in the spectrum, i.e. a shift in transition energy by a factor of $\sqrt{2}$ (see Eq.2.52). Note here that the reduced mass μ has to be considered to calculate the vibrational frequency, which for biatomic molecules with atomic masses m_1 and m_2 is given as:

$$\mu = \frac{m_1 \cdot m_2}{m_1 + m_2} \quad (\text{Eq.2.53})$$

On the other hand, the energy spacing between the two peaks closest to this gap allows one to extract the bond length, since it is directly related to the rotational energy or moment of inertia.

Finally, one should note the interesting intensity distribution within a peak series: at room temperature, typically the 3rd peak shows the highest absorption intensity. This is caused by the fact that, according to the Boltzmann distribution, the 3rd rotational state has the highest probability, as a compromise of its degree of degeneration (which scales as $(2J + 1)$) and the exponential term in the Boltzmann probability function, i.e.

$$\frac{N_J}{N_0} = (2J + 1) \cdot \exp\left(-\frac{hcB \cdot J \cdot (J+1)}{kT}\right) \quad (\text{Eq.2.54})$$

with $hcB \cdot J \cdot (J + 1)$ the rotational energy of the state with rotational quantum number J , and B the rotational constant which is given by the moment of inertia of the rotating molecule, i.e. atomic masses and bond length. Finally, one should note that the absorption peaks in the spectrum actually are double-peaks, which is due to the fact that Cl-atoms are found in form of two isotopes of slightly different atomic masses.

In most cases, the spectrum is not as symmetrical as sketched above, but shows a red-shift of all transitions due to rotation-vibration-coupling: the average bond length, and therefore the moment of inertia and the rotational constant B , depends on the vibrational state. Typically, the anharmonicity of the oscillation potential leads to $B(v=1) < B(v=0)$, as shown in figures 2.11 and 2.12. As a consequence, all transitions, as shown schematically in figure 2.12, are energetically smaller compared to the ideal case of a harmonic oscillator potential, with constant B independent of vibrational state v , and the spectrum is asymmetrically shifted to shorter wavelengths. The change of the average bond lengths with vibrational excitation is illustrated in figure 2.11:



What do you want to do?

No matter what you want out of your future career, an employer with a broad range of operations in a load of countries will always be the ticket. Working within the Volvo Group means more than 100,000 friends and colleagues in more than 185 countries all over the world. We offer graduates great career opportunities – check out the Career section at our web site www.volvogroup.com. We look forward to getting to know you!

VOLVO
AB Volvo (publ)
www.volvogroup.com

VOLVO TRUCKS | RENAULT TRUCKS | MACK TRUCKS | VOLVO BUSES | VOLVO CONSTRUCTION EQUIPMENT | VOLVO PENTA | VOLVO AERO | VOLVO IT
VOLVO FINANCIAL SERVICES | VOLVO 3P | VOLVO POWERTRAIN | VOLVO PARTS | VOLVO TECHNOLOGY | VOLVO LOGISTICS | BUSINESS AREA ASIA



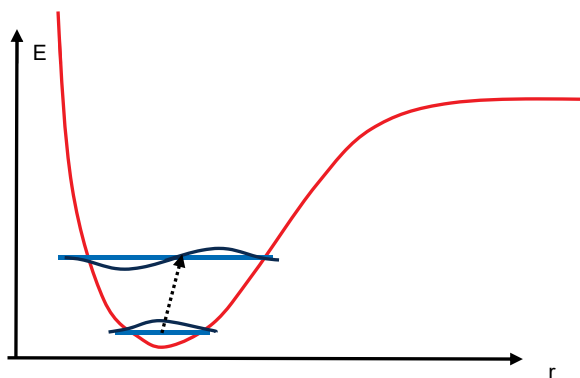

Figure 2.11.: Inharmonic or Morse potential, and increase in average bond length upon excitation of vibrations as indicated by the dotted arrow.

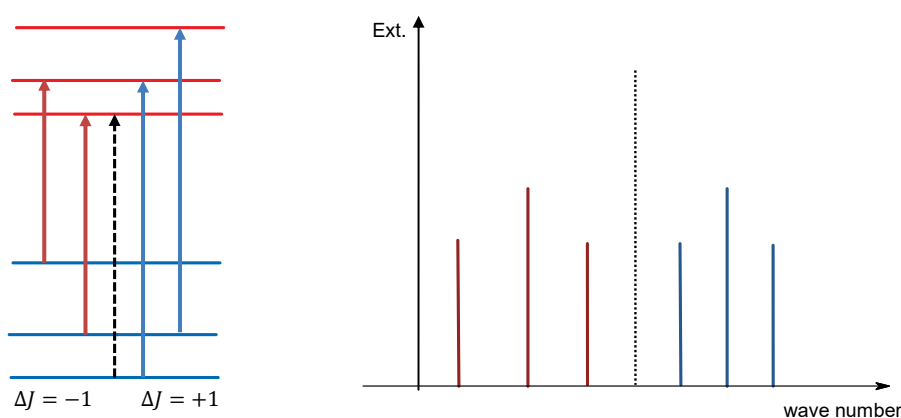

Figure 2.12.: Energy transitions (left) and corresponding rotational-vibrational spectrum of HCl (right), asymmetry caused by rotation-vibrational-coupling. Dotted line corresponds to the hypothetical transition $\Delta J = 0$ not found in the HCl-spectrum.

If we define $B (v = 0)$ as B' , and $B (v = 1)$ as B'' , then rotation-vibration coupling leads to an energetic separation (in terms of wave numbers) of the two spectral series by $2 B' + 2 B''$, compared to $4 B$ for the strictly harmonic case.

Before we conclude this section about high resolution IR rotation vibration spectra with a numerical example, let us consider how the moment of inertia of a diatomic molecule like HCl depends on atomic masses, applying again the concept of the reduced mass (see Eq.2.53). Our molecule is defined in figure 2.13:

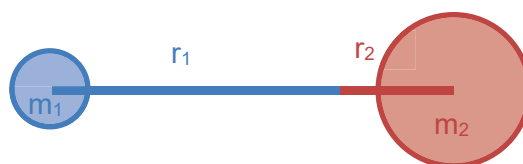

Figure 2.13.: Sketch of a diatomic molecule with atomic masses m_1, m_2 and distances of the atoms to the center of mass r_1, r_2 , respectively.

The center of mass of this molecule is given by the condition;

$$m_1 \cdot r_1 = m_2 \cdot r_2 \quad (\text{Eq.2.55})$$

with the total bond length corresponding to $l = r_1 + r_2$.

The moment of inertia also depends on the reduced mass (like the oscillation frequency, see Eq.(2.52)), and on the total bond length, as can be shown easily:

$$\begin{aligned} I &= \sum m_i \cdot r_i^2 = m_1 \cdot r_1^2 + m_2 \cdot r_2^2 = \frac{m_1 \cdot (m_1 + m_2) \cdot r_1^2 + m_2 \cdot (m_1 + m_2) \cdot r_2^2}{(m_1 + m_2)} = \\ &= \frac{m_1^2 \cdot r_1^2}{(m_1 + m_2)} + \mu \cdot r_1^2 + \frac{m_2^2 \cdot r_2^2}{(m_1 + m_2)} + \mu \cdot r_2^2 = \\ &= \frac{m_1}{m_2} \cdot \mu \cdot r_1^2 + \mu \cdot r_1^2 + \frac{m_2}{m_1} \cdot \mu \cdot r_2^2 + \mu \cdot r_2^2 = \\ &= \mu \cdot r_1 \cdot r_2 + \mu \cdot r_1^2 + \mu \cdot r_2 \cdot r_1 + \mu \cdot r_2^2 = \\ &= \mu \cdot (r_1^2 + 2 \cdot r_1 \cdot r_2 + r_2^2) = \\ &= \mu \cdot (r_1 + r_2)^2 = \mu \cdot l^2 \end{aligned} \quad (\text{Eqs.2.56})$$

Finally, we conclude this section with one numerical example:

Example 2.2:

In the high-resolution IR spectrum of HCl, measured for a gaseous sample at low pressure, we find a band gap at frequency $8.66 \cdot 10^{13} \text{ s}^{-1}$, and an inner spacing between the two series of rotational transitions of $0.12 \cdot 10^{13} \text{ s}^{-1}$ (see also fig. 2.10). Calculate the bond strength and bond length of the molecule. (note: ignore the rotation-vibration coupling and the dissymmetry of the spectrum, and simply take the inner band gap as $4B$)

Solution:

(i) bond strength

For the HCl molecule, the needed reduced mass is

$$\mu = \frac{M_H \cdot M_{Cl}}{M_H + M_{Cl}} = \frac{1 \cdot 35}{1 + 35} \text{ g/Mol} = 0.98 \text{ g/Mol}$$

Note that this is almost the mass of the hydrogen. Substituting the midpoint frequency into the expression containing the bond force constant gives:

$$2\pi \cdot \nu = 6.28 \cdot 8.66 \cdot 10^{13} \text{ s}^{-1} = \sqrt{\frac{k}{\mu}}$$

$$k = (6.28 \cdot 8.66 \cdot 10^{13})^2 \cdot \frac{0.98 \cdot 10^{-3}}{6.02 \cdot 10^{23}} \text{ N/m} = 481 \text{ N/m}$$

(ii) bond length

The separation between the two series of spectral peaks is four times the rotational energy change from quantum number $J = 0$ to $J = 1$. This energy is related to the momentum of inertia, i.e.

$$\Delta E = h \cdot c \cdot 4B = \frac{1}{I} \cdot h \cdot c \cdot 4 \cdot \frac{h}{8\pi^2 \cdot c} = h \cdot 0.12 \cdot 10^{13} \text{ s}^{-1} \quad , \quad \text{with} \quad I = \mu \cdot l^2$$

Therefore, the bond length is given as:

$$l^2 = \frac{h}{\mu \cdot 2 \cdot \pi^2 \cdot 0.12 \cdot 10^{13} \text{ s}^{-1}} = \frac{6.626 \cdot 10^{-34}}{\frac{0.98 \cdot 10^{-3}}{6.02 \cdot 10^{23}} \cdot 2 \cdot \pi^2 \cdot 0.12 \cdot 10^{13}} \text{ m}^2 = 1.72 \cdot 10^{-20} \text{ m}^2$$

This corresponds to a bond length of 0.13 nm.

2.4.3 Raman scattering – molecular vibration transitions

As already mentioned, not all molecular vibrations can be excited by optical irradiation: Fermi's golden rule tells us that the electric dipole moment of a molecule has to change during the vibrational oscillations. Therefore, homologous biatomic molecules like, for example, Cl_2 , are invisible in IR absorption spectroscopy, and it is also not possible to measure (by IR absorption spectroscopy) the molecular bond strength needed, for example, as input parameter in statistical thermodynamics to calculate the heat capacity as a function of temperature for Cl_2 . Here, Raman spectroscopy, which is an inelastic scattering technique, provides an adequate solution, and therefore often is considered as a method complimentary to IR spectroscopy. Raman scattering also allows to access changes in polarization of incident and scattered light, thereby enabling an accurate assessment of molecular vibrations in conjunction with so-called group theory, a concept most useful for symmetry analysis of molecular vibrations and chemical bonds in molecules or chemical complexes. Therefore, we will also briefly introduce the mathematical concept of group theory in a separate chapter of this book.

Raman scattering is based on the irradiation of the sample with a beam of well-defined polarized monochromatic, highly intense, light. The major part of the scattered light, also called Rayleigh scattering, will then have the same wavelength as the incident light. Note, however, that even the Rayleigh peak shows a slight broadening in wavelength due to the Doppler effect, which may be exploited to determine the velocity of molecules in the gaseous state (see Eqs.(2.18), (2.19)). Also, the intensity of the Rayleigh peak scales with the polarizability of the scattering molecules, which is a measure how easy the incident electromagnetic wave may induce an oscillating dipole acting as an emitter. Finally, the scattered intensity scales with the frequency of the incident light to the power 4.

In addition to the main (quasi elastic) Rayleigh peak, molecules may also show two inelastic scattering peaks of much smaller intensity, called Stokes and Anti Stokes peak, respectively. In this case, molecular vibrations are coupled to the light emitting oscillating electric dipole, and the respective vibration energy is either subtracted (Stokes-peak, red-shifted compared to the Rayleigh peak) or added to the energy of the emitted light wave (Anti Stokes peak, blue-shifted compared to the Rayleigh peak). A Raman spectrum therefore consists of the detected scattered intensity, typically measured in an angle of 90° or even 180° (back scattering) in respect to the incident light beam, plotted vs. the wavelength or wavenumber of the scattered light. Typically, the wavenumber of the incident light or Rayleigh peak is set to zero, and the Rayleigh peak because of its high intensity is blocked from the detector, and the Stokes peak is detected as a function of wavenumber shift (Stokes shift). Figure 2.14 summarizes the molecular energetic transitions involved in Raman spectroscopy, and sketches the resulting Raman spectrum. Note that the blue-shifted Anti Stokes peak is usually much lower in intensity than the red-shifted Stokes peak, reflecting the difference in thermal population of the vibrational ground and the vibrational excited state as defined by the Boltzmann distribution (see chapter 1).

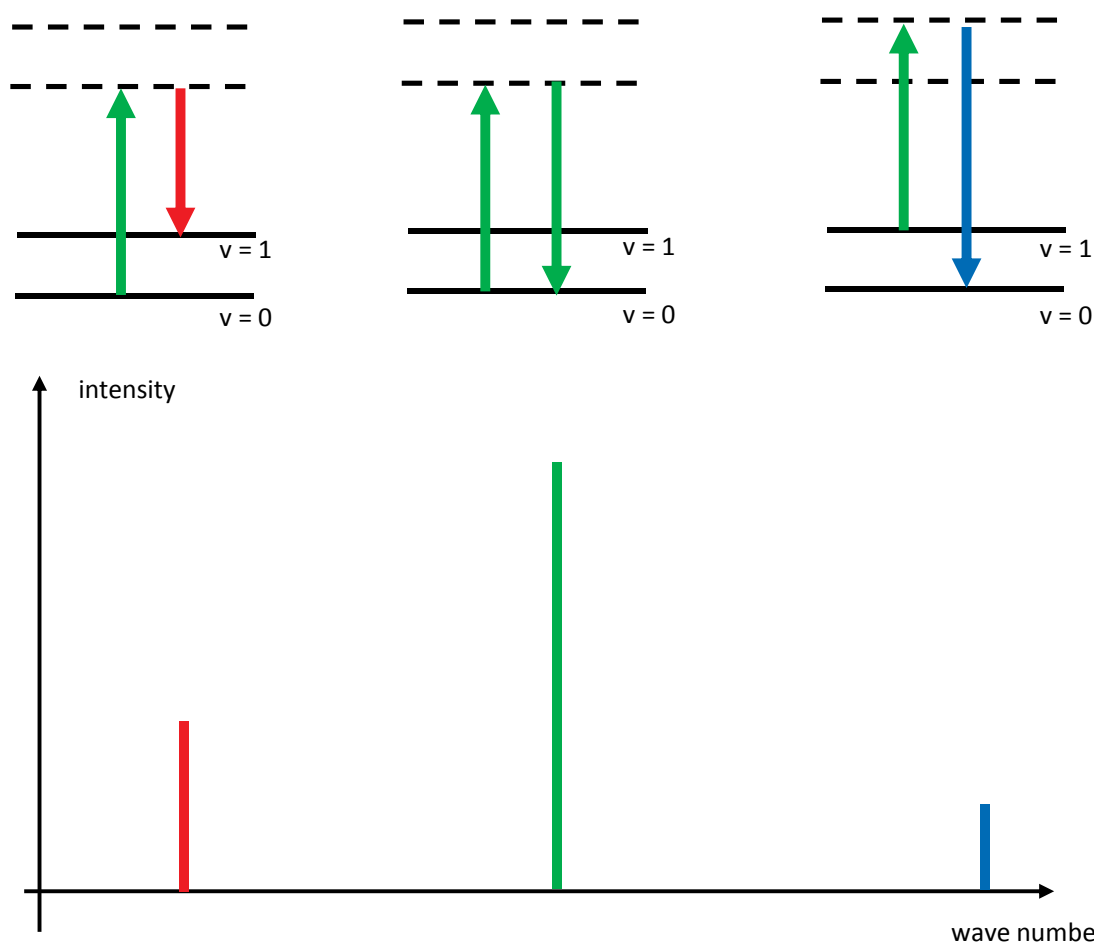

Fig. 2.14: molecular energetic transitions involved in a Raman spectrum, and sketch of the resulting Raman spectrum. $v = 0, 1$ are the vibrational ground and the first excited state, respectively. Dashed horizontal lines are so-called virtual electronically excited states. See text for details.

As mentioned, the electric field of the incident light induces an oscillating electric dipole moment which is directly proportional to the electric field strength, the proportionality given by the polarizability of the molecule, α :

$$\vec{\mu} = \alpha \cdot \vec{E} = \alpha \cdot \vec{E}_0 \cdot \cos(2\pi \cdot \nu_0 \cdot t) \quad (\text{Eq.2.57})$$

with ν_0 the frequency of the incident light, and \vec{E}_0 its electric field vector. Note that the polarizability α is a tensor of 2nd rank, indicating that the direction of the oscillating electric dipole moment vector may be different from the polarization direction of the incident electric field vector. We will keep this property of the polarizability tensor in mind when we discuss the symmetry of molecular vibrations visible in Raman scattering in chapter 3. An important condition for Raman active vibrations is that the polarizability changes with the atomic coordinates q . As a first approximation, this dependence of the polarizability on the atomic coordinates of a vibrating molecule can be expressed as a Taylor series expansion around the equilibrium atomic configuration, i.e.

$$\alpha = \alpha_{q=0} + \left(\frac{d\alpha}{dq}\right)_{q=0} \cdot q + \dots \quad (\text{Eq.2.58})$$

Here, we are interested only in changes of the atomic coordinates q due to harmonic molecular vibrations, therefore

$$q = q_0 \cdot \cos(2\pi \cdot \nu_M \cdot t) \quad (\text{Eq.2.59})$$

gaiTeye
Challenge the way we run

EXPERIENCE THE POWER OF FULL ENGAGEMENT...

**RUN FASTER.
RUN LONGER..
RUN EASIER...**

**READ MORE & PRE-ORDER TODAY
WWW.GAITEYE.COM**

with ν_M the frequency of the molecular vibration, and q_0 the amplitude of this vibration. Note that this frequency is identical to that of IR light needed to incite the molecular vibration directly by light absorption, in case this vibration would show a change in the electric dipole moment of the molecule. If we insert Eqs. (2.58) and (2.59) in the expression for the induced electric dipole moment, we get:

$$\vec{\mu} = \alpha \cdot \vec{E} = \left(\alpha_{q=0} + \left(\frac{d\alpha}{dq} \right)_{q=0} \cdot q_0 \cdot \cos(2\pi \cdot \nu_M \cdot t) \right) \cdot \vec{E}_0 \cdot \cos(2\pi \cdot \nu_0 \cdot t) \quad (\text{Eq.2.60})$$

or, using the theorem for the multiplication of two cosine functions:

$$\begin{aligned} \vec{\mu} &= \alpha \cdot \vec{E}_0 \cdot \cos(2\pi \cdot \nu_0 \cdot t) \\ &+ \frac{1}{2} \cdot \left(\frac{d\alpha}{dq} \right)_{q=0} \cdot q_0 \cdot \vec{E}_0 \cdot \{ \cos[2\pi \cdot (\nu_0 + \nu_M) \cdot t] + \cos[2\pi \cdot (\nu_0 - \nu_M) \cdot t] \} \end{aligned} \quad (\text{Eq.2.61})$$

Here, the first part of this equation corresponds to the electric dipole oscillations responsible for the elastic Rayleigh scattering (ν_0), and the second part to the oscillations causing the Stokes ($(\nu_0 - \nu_M)$) and the Anti Stokes ($(\nu_0 + \nu_M)$) peaks, respectively. Eq. (2.61) shows directly the important selection rule telling if a molecular vibration is visible in Raman scattering: the polarizability has to change with the harmonic oscillation of the molecule:

$$\left(\frac{d\alpha}{dq} \right)_{q=0} \neq 0 \quad (\text{Eq.2.61})$$

The total number of so-called normal modes of vibration of a non-linear molecule, consisting of N atoms, is given by $3N - 6$, since each molecule consisting of N atoms has $3N$ degrees of freedom (= modes of atomic motion). These degrees of freedom correspond to position changes of each atom of the molecule in direction of the respective Cartesian coordinates x , y and z . 3 of these modes are attributed to translation of the overall molecule in directions x , y and z (all atoms moving the same distance in the same direction), and another 3 modes are attributed to molecular rotations around three different axes pointing in directions x , y or z , respectively. Note here that, for linear molecules, like for example CO_2 , one of these rotational modes disappears, since the moment of inertia in respect to rotation around the principle molecular axis in this case is zero. For linear molecules, we therefore expect $3N - 5$ normal modes of vibration.

Let us conclude this chapter considering the molecular degrees of freedom, and the corresponding vibrational modes, of a slightly more complicated non-linear molecule. Ammonia (NH_3), for example, should have 6 different molecular vibrational modes ($3N = 12$, minus 3 modes of translation and rotation, respectively). The vibrational modes with a change in the electric dipole moment should be IR active, whereas those with a change in polarizability should be Raman active. Note that some modes may be neither IR nor Raman active, or both. Whereas it is simple to check these selection rules for biatomic molecules like HCl or Cl_2 , it is impossible to address the vibrations of molecules with 3 or more atoms, in respect to their detectability in optical spectroscopy, without a suitable concept of symmetry analysis. The mathematical concept of group theory here provides a solution, and therefore it will briefly be introduced in the last chapter of this book.

3 Group theory

In this chapter, I will introduce the concept of point group theory and character tables. This mathematical concept is essential to analyze fundamental problems in chemistry, like the symmetry of molecular vibrations, or the symmetry of molecular electronic orbitals. Group theory is based on simple symmetry operations like regular rotations, mirror planes, points of inversion, etc., and matrix calculation. It will be shown how group theory is used to predict if molecular vibrations or electronic transitions can be excited by the absorption of light.

For further reading, I recommend, for example, the textbook “Physical chemistry” by P. Atkins, chapters “molecular symmetry” and “spectroscopy 1, 2”. Here, I shall point out that the mathematically exact formalism of group theory is a rather complicated subject, especially for beginners. Since this ebook shall, however, not replace common textbooks on the subject but rather provide a comprehensive overview on the topics statistical thermodynamics and spectroscopy, this chapter about group theory only tries to provide an idea of the formalism (“learning by viewing”), skipping sometimes the exact mathematical background.

3.1 C_{2v} – a simple example to introduce the concept

We start with the character table of the 3-atomic molecule H_2O as a comparatively simple example:

C_{2v}	E	C_2	$\sigma_v(xz)$	$\sigma'_v(yz)$	
A_1	1	1	1	1	z, x^2, y^2, z^2
A_2	1	1	-1	-1	Rz, xy
B_1	1	-1	1	-1	x, R_y, xz
B_2	1	-1	-1	1	y, R_x, yz

Table 3.1: character table of symmetry point group C_{2v} (e.g. H_2O molecule)

The first row of the character table contains the name of the symmetry point group in the upper left corner. Here, C_{2v} symbolizes a molecule with a C_2 rotation axis (molecule looks identical if rotated by 180° around its principle symmetry axis), and vertical mirror planes σ_v . Next, the first row of the table (shaded in gray) contains the symmetry operations characteristic for the given point group, in this case the identity E (corresponding to rotation by 360°), the C_2 rotation axis already mentioned, and two different vertical mirror planes. The coordinates x , y and z are defined according to a certain orientation of our molecule in space, as shown in figure 3.1:

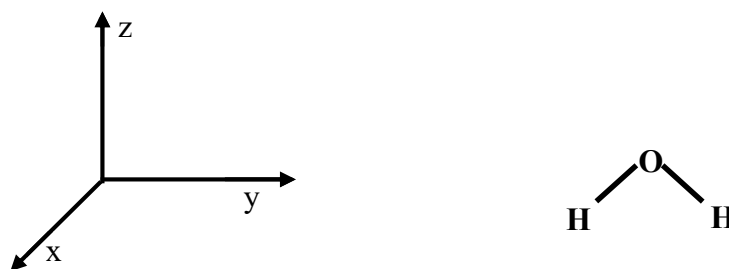
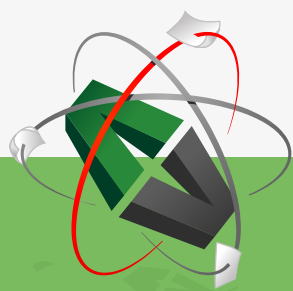

Figure 3.1: Cartesian coordinate system and corresponding orientation of the H_2O molecule.

In the last column of the character table, we find basic operations, like translation along the Cartesian axes (x , y , z), or rotations around an Cartesian axis (R_x , R_y , R_z), which show the same symmetry as the irreducible representations (see below) listed in the first column (here: A_1 , A_2 , B_1 , B_2). Here, the letter A symbolizes 1-dimensional representations which are symmetric in respect to the principle rotation axis, whereas the letter B symbolizes 1-dimensional representations which are antisymmetric in respect to this axis. In addition, we also find products of Cartesian coordinates, like xy , xz etc. These products are needed to determine if a vibrational mode is detectable in Raman spectroscopy, as we will explain later in more detail.

This e-book
is made with
SetaPDF



PDF components for PHP developers

www.setasign.com



The irreducible representations are the basic set of the reducible representations of each symmetry operation. Note that, for each symmetry point group there exist an arbitrary number of reducible representations, but only those irreducible representations which are defined in the character table. Mathematically, a symmetry operation changes a vector, containing all atomic positions with their respective Cartesian position vectors in all 3 spatial directions x, y and z (therefore, a vector of total dimension $3N$, N being the number of atoms of the molecule), into a new $3N$ -dimensional vector (or atomic configuration of the molecule), as we will explain for a few examples soon. Therefore, the symmetry operation is mathematically represented by a matrix, in case of the reducible representations by a matrix of dimension $3N \times 3N$. This matrix can be rewritten as the sum of smaller matrices, the so-called irreducible representations of the symmetry operation. These smaller matrices, on the other hand, cannot be represented by the sum of even smaller matrices, and therefore are called irreducible. Principally, this is similar to the procedure of rewriting a (reducible) vector in 3d space as the sum of three (irreducible) orthogonal vectors in directions x, y and z, with respective contributions:

$$\begin{pmatrix} a \\ b \\ c \end{pmatrix} = a \cdot \begin{pmatrix} 1 \\ 0 \\ 0 \end{pmatrix} + b \cdot \begin{pmatrix} 0 \\ 1 \\ 0 \end{pmatrix} + c \cdot \begin{pmatrix} 0 \\ 0 \\ 1 \end{pmatrix} \quad (\text{Eq.3.1})$$

This analogy of simple vector algebra to the more complicated matrix calculations, used to describe symmetry operations in group theory, is even more justified if one considers that in practice of group theory not the whole transformation matrix, but only its diagonal elements, have to be considered. The sum of these diagonal elements is called the character of the corresponding matrix. Note that the diagonal elements basically form a vector, which is $3N$ -dimensional for any reducible representation of the molecule. Irreducible representations then are, if one only considers the diagonal elements of the corresponding transformation matrices, vectors of dimensions 1 (abbreviated in character tables with letters A, B), 2 (E), to a maximum of 3 (T). The numbers in the character table therefore finally represent the characters, or sums of the diagonal elements, of the smaller irreducible matrices. Lost you? Let us illustrate this principle of reducible and irreducible matrix representation of symmetry operations, and especially how the characters of the reducible representations are determined, in more detail, using our simple example molecule H_2O :

First, let us consider how the symmetry operation C_2 (= rotation by 180° around the z-axis) transforms the original position vectors of the individual atoms of our H_2O molecule, as sketched in figure 3.2:

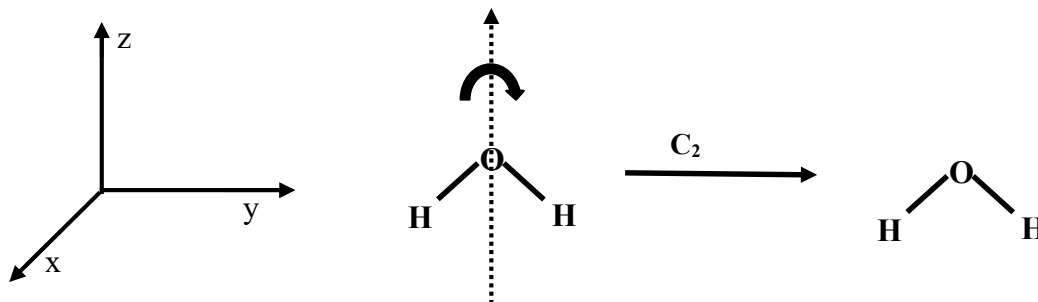

Figure 3.2: Change in position vectors of the atoms of H₂O at symmetry operation C₂.

If the vector coordinates of the original molecular configuration are defined as following:

$$(H_{1,x}, H_{1,y}, H_{1,z}, O_x, O_y, O_z, H_{2,x}, H_{2,y}, H_{2,z}) = (q_1, q_2, q_3, q_4, q_5, q_6, q_7, q_8, q_9) \quad (\text{Eq.3.2})$$

then the symmetry operation C₂ transforms this vector into:

$$(q_1, q_2, q_3, q_4, q_5, q_6, q_7, q_8, q_9) \rightarrow (-q_7, -q_8, q_9, -q_4, -q_5, q_6, -q_1, -q_2, q_3) \quad (\text{Eq.3.3})$$

For example, the y-vector of the left H-atom becomes the y-vector of the right H-atom in negative direction, and therefore q₂ changes to -q₈. In general, the transformation of one vector into another one of the same dimension 3N is mathematically described by the multiplication of the original vector with a matrix of dimension 3N × 3N, i.e.:

$$\vec{q}' = \Gamma \cdot \vec{q} \quad (\text{Eq.3.4})$$

The transformation matrix Γ for the C₂ rotation of the H₂O molecule is then given as:

$$\Gamma = \begin{bmatrix} 0 & 0 & 0 & 0 & 0 & 0 & -1 & 0 & 0 \\ 0 & 0 & 0 & 0 & 0 & 0 & 0 & -1 & 0 \\ 0 & 0 & 0 & 0 & 0 & 0 & 0 & 0 & 1 \\ 0 & 0 & 0 & -1 & 0 & 0 & 0 & 0 & 0 \\ 0 & 0 & 0 & 0 & -1 & 0 & 0 & 0 & 0 \\ 0 & 0 & 0 & 0 & 0 & 1 & 0 & 0 & 0 \\ -1 & 0 & 0 & 0 & 0 & 0 & 0 & 0 & 0 \\ 0 & -1 & 0 & 0 & 0 & 0 & 0 & 0 & 0 \\ 0 & 0 & 1 & 0 & 0 & 0 & 0 & 0 & 0 \end{bmatrix} \quad (\text{Eq.3.5})$$

This can easily be confirmed, if we consider that the first component of the new vector \vec{q}' is given by multiplication of a 3N-dimensional vector, corresponding to the first row of the matrix, with the vector \vec{q} , and so on..., i.e.

$$q'_1 = \begin{pmatrix} 0 \\ 0 \\ 0 \\ 0 \\ 0 \\ -1 \\ 0 \\ 0 \end{pmatrix} \cdot \begin{pmatrix} q_1 \\ q_2 \\ q_3 \\ q_4 \\ q_5 \\ q_6 \\ q_7 \\ q_8 \\ q_9 \end{pmatrix} = -q_7 \quad (\text{Eq.3.6})$$

Free eBook on Learning & Development

By the Chief Learning Officer of McKinsey

[Download Now](#)

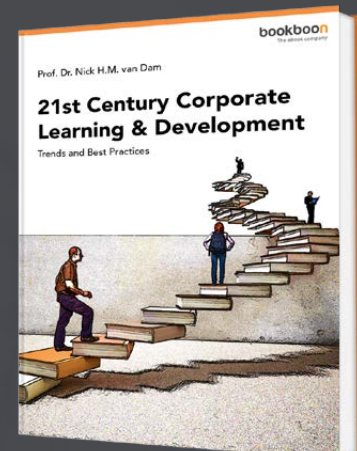

[Click on the ad to read more](#)

The character of this matrix, or sum of the diagonal elements, is given as $\chi(C_2) = -1 - 1 + 1 = -1$. Here, one should note that the diagonal elements are only non-zero in case an atom does not change its position at the symmetry operation. In case of the C_2 operation, both H atoms swap their positions while the O atom stays at its place and only changes the orientations of its Cartesian position vectors in x- and y-direction. In general, the character of any transformation matrix can easily be determined if we just consider the atoms not changing their position, and think about how their respective Cartesian coordinates change. This rather simple concept then leads to the following characters of the reducible matrix representations for all symmetry operations belonging to the point group C_{2v} :

$$\begin{aligned}\chi(E) &= 1 + 1 + 1 + 1 + 1 + 1 + 1 + 1 + 1 = 9 && \text{(all 3 atoms unchanged)} \\ \chi(C_2) &= 0 + 0 + 0 - 1 - 1 + 1 + 0 + 0 + 0 = -1 && \text{(only O-atom stays at position)} \\ \chi(\sigma_{v,xz}) &= 0 + 0 + 0 + 1 - 1 + 1 + 0 + 0 + 0 = 1 && \text{(only O-atom stays at position)} \\ \chi(\sigma_{v,yz}) &= -1 + 1 + 1 - 1 + 1 + 1 - 1 + 1 + 1 = 3 && \text{(all 3 atoms stay at position)}\end{aligned}\quad (\text{Eqs.3.7})$$

This result is summarized in the following table, not to be confused with the character table containing only the irreducible representations:

C_{2v}	E	C_2	$\sigma_v(xz)$	$\sigma'_v(yz)$
Γ	9	-1	1	3

Table 3.2: characters of the reducible representations for the symmetry operations of symmetry point group C_{2v} (e.g. H_2O molecule)

To determine the symmetry of the molecular vibrations, and if they are visible in IR-spectroscopy, or Raman-spectroscopy, or both, we next have to analyze the reducible representation, corresponding to the $3N$ degrees of freedom (translation plus rotation plus vibration) in respect to its underlying basic irreducible symmetries. This is achieved by considering that the reducible representation is the sum of 9 irreducible one-dimensional representations (listed in the character table 3.1). The contribution of each of these irreducible representations (A_1 , A_2 , B_1 , B_2) is calculated then by taking into account that the sum of the respective characters has to be equal to the characters of the reducible representation given in tab.3.2, leading to 4 equations (one for each symmetry operation) with 4 unknown quantities c_1 to c_4 , the respective contributions of each irreducible representation to Γ :

$$\Gamma = c_1 \cdot A_1 + c_2 \cdot A_2 + c_3 \cdot B_1 + c_4 \cdot B_2 \quad (\text{Eq.3.8})$$

Note that the total number of 1d irreducible contributions to the reducible representation has to equal $3N$, i.e. in case of our H_2O molecule, $c_1 + c_2 + c_3 + c_4 = 9$. This also corresponds to the solution of Eq.(3.8) for the symmetry operation E . It can be shown (see textbooks) that, more general, the coefficients c_i may be calculated using the formula:

$$c_i = \frac{1}{h} \cdot \sum_k (h_k \cdot \chi^i(R) \cdot \chi(R)) \quad (\text{Eq.3.9})$$

with h the order of the group (or number of basic symmetry operations, here $h = 4$), h_k the dimension of the irreducible representations (here, $h_k = 1$ in all cases), R the respective symmetry operations, and $\chi^i(R)$ and $\chi(R)$ the characters of the respective irreducible and reducible representations. This formula then leads to the following results (the respective characters are found in tables 3.1 and 3.2):

$$\begin{aligned}c_1(A_1) &= \frac{1}{4} \cdot (1 \cdot 1 \cdot 9 + 1 \cdot 1 \cdot (-1) + 1 \cdot 1 \cdot 1 + 1 \cdot 1 \cdot 3) = 3 \\c_2(A_2) &= \frac{1}{4} \cdot (1 \cdot 1 \cdot 9 + 1 \cdot 1 \cdot (-1) + 1 \cdot (-1) \cdot 1 + 1 \cdot (-1) \cdot 3) = 1 \\c_3(B_1) &= \frac{1}{4} \cdot (1 \cdot 1 \cdot 9 + 1 \cdot (-1) \cdot (-1) + 1 \cdot 1 \cdot 1 + 1 \cdot (-1) \cdot 3) = 2 \\c_4(B_2) &= \frac{1}{4} \cdot (1 \cdot 1 \cdot 9 + 1 \cdot (-1) \cdot (-1) + 1 \cdot (-1) \cdot 1 + 1 \cdot 1 \cdot 3) = 3\end{aligned}\quad (\text{Eqs.3.10})$$

And therefore the reducible representation is finally given as:

$$\Gamma = 3 \cdot A_1 + 1 \cdot A_2 + 2 \cdot B_1 + 3 \cdot B_2 \quad (\text{Eq.3.11})$$

To identify the symmetry of the vibrational modes, we have to subtract the translational and rotational molecular degrees of freedom first from the expression given in Eq.(3.11). According to the character table (see tab.3.1), the translations x , y and z have the symmetries of A_1 , B_1 and B_2 , whereas the rotations around the 3 different Cartesian axes R_x , R_y and R_z have the symmetries of A_2 , B_1 and B_2 . Subtracting these 6 irreducible representations from the reducible representation then leads us to the following symmetries for the 3 vibrational normal modes of the H_2O molecule:

$$\Gamma_{\text{vib}} = 2 \cdot A_1 + B_2 \quad (\text{Eq.3.12})$$

We expect therefore two vibrational normal modes to be totally symmetric (A_1), and one mode to be antisymmetric in respect to rotation by 180° around the principle z -axis (B_2). For a simple molecule like H_2O , these vibrations could be visualized as following:

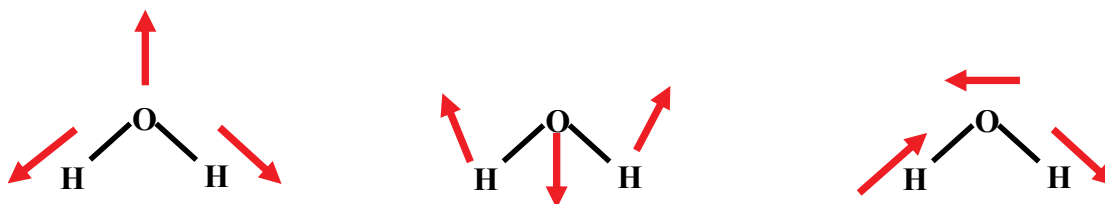

Fig.3.3: visualization of the 3 vibrational modes of H_2O : symmetric bond stretching (left) and bond deformation (center), and antisymmetric bond stretching (right).

Finally, we have to determine which of these vibrations are detectable by spectroscopic methods. Again, here the character table is very helpful: this time, we use its right column to analyze the symmetry of the irreducible representations in respect to the symmetry of an electric dipole moment, which is a vector with Cartesian components (x, y, z) , or the symmetry of the polarizability, which is represented by a 3×3 dimensional matrix and therefore contains the 9 matrix elements $(x^2, xy, xz, yx, y^2, yz, zx, zy, z^2)$.

C_{2v}	E	C_2	$\sigma_v(xz)$	$\sigma'_v(yz)$	
A_1	1	1	1	1	z, x^2, y^2, z^2
A_2	1	1	-1	-1	R_x, xy
B_1	1	-1	1	-1	x, R_y, xz
B_2	1	-1	-1	1	y, R_x, yz

Table 3.1: character table of symmetry point group C_{2v} (e.g. H_2O molecule). Marked in red are IR active vibrational modes, marked in green are Raman active vibrational modes.



www.sylvania.com

We do not reinvent the wheel we reinvent light.

Fascinating lighting offers an infinite spectrum of possibilities: Innovative technologies and new markets provide both opportunities and challenges. An environment in which your expertise is in high demand. Enjoy the supportive working atmosphere within our global group and benefit from international career paths. Implement sustainable ideas in close cooperation with other specialists and contribute to influencing our future. Come and join us in reinventing light every day.

Light is OSRAM

OSRAM SYLVANIA 



Click on the ad to read more

The character table shows that both the A_1 modes and the B_2 mode correspond in symmetry to Cartesian coordinates as well as to products of Cartesian coordinates. We therefore may conclude that, in case of a sample containing many H_2O molecules in random orientation in respect to the director of the electric field vector of the incident light, all 3 modes are visible in both IR and Raman spectroscopy. Note, however, if we would prepare a solid sample with all molecules oriented in z-direction as sketched in figure 3.1, then the vibrations could not be detected with IR light linearly polarized in x-direction (since the transition dipole moment of the molecular vibrations of H_2O has no symmetry component in x-direction perpendicular to the principle molecule axis).

3.2 The point group C_{3v}

Let us discuss next the point group C_{3v} , as an example for a more complicated (compared to H_2O) molecules, like NH_3 or $CHCl_3$. The corresponding character table is given in table 3.3:

C_{3v}	E	$2C_3$	$3\sigma_v$	
A_1	1	1	1	$z; x^2+y^2; z^2$
A_2	1	1	-1	R_z
E	2	-1	0	$(x,y); (R_x,R_y); (x^2-y^2, xy); (xz,yz)$

Table 3.3: character table of symmetry point group C_{3v} (e.g. $CHCl_3$ molecule)

C_{3v} symbolizes a molecule with a C_3 rotation axis (molecule looks identical if rotated by 120° , clockwise or counter-clockwise, therefore this rotation is abbreviated as $2C_3$ in character tables), and 3 vertical mirror planes σ_v . Again, the coordinates x , y and z are arbitrarily defined according to a certain orientation of our molecule in space (note that the orientation of the molecule has to be chosen in consistence with the character table. The right column in tab.3.3 shows that the z -vector is totally symmetric in our case (irreducible representation A_1 , the characters of 1 for all symmetry operations indicate that the z -vector does not change for any of the symmetry operations), and therefore the z -axis is the principle rotation axis of the H_2O molecule), as shown in figure 3.4. Here, we should note that the choice of the x and y axis in this case has no consequence on the formalism: a 2d vector within the xy -plane, that is, perpendicular to the principle rotation axis, will always correspond to the irreducible representation E , as we will illustrate for one example below. As already mentioned before, E corresponds to a 2d irreducible representation, as for example the 2d-vector (x, y) (see right column). Character tables for other symmetry point groups may contain irreducible representations which are even 3d, called T .

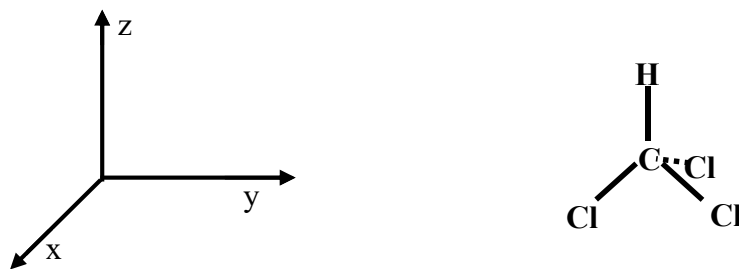

Figure 3.4: Cartesian coordinate system and corresponding orientation of the HCCl_3 molecule.

Before we continue, let us illustrate why a 2d-vector in the xy -plane should correspond to the irreducible basis E defined in the character table. Let us consider an arbitrary 2d vector in the xy -plane, $(1, 1)$ for example. This vector has a total length of $\sqrt{2}$. If it is rotated by 120° around the z -axis, the x - and y -coordinates, respectively, change as following: $x_1 = 1$ becomes $x_2 = -\sqrt{2}$, whereas $y_1 = 1$ becomes $y_2 = \sqrt{2}$. The corresponding rotation matrix transforming the vector (x, y) then, in analogy to Eq.(3.4), is given as:

$$\begin{pmatrix} -\sqrt{2} \cdot \cos 15^\circ \\ \sqrt{2} \cdot \sin 15^\circ \end{pmatrix} = \begin{pmatrix} -\sqrt{2} \cdot \cos 15^\circ & 0 \\ 0 & \sqrt{2} \cdot \sin 15^\circ \end{pmatrix} \cdot \begin{pmatrix} 1 \\ 1 \end{pmatrix} \quad (\text{Eq.3.13})$$

and the corresponding character of this matrix is given as $-\sqrt{2} \cdot \cos 15^\circ + \sqrt{2} \cdot \sin 15^\circ = -1$, in agreement with the irreducible basis E in the character table (see tab.3.3). For clarification, this C_3 operation of a vector $(1, 1)$ is also shown in figure 3.5.:

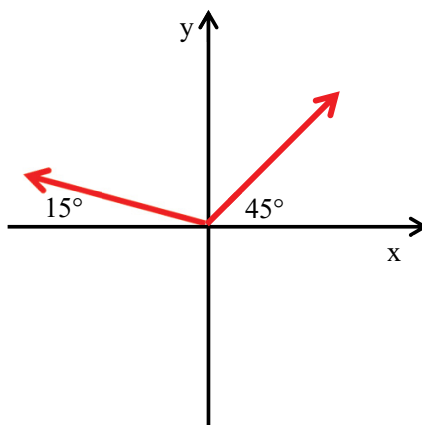

Fig.3.5: C_3 operation of a vector $(1, 1)$ in the xy -plane (in red), rotated counterclockwise by 120° around the z -axis.

Finally, let us also consider the operation σ_v in respect to our 2d vector. According to our molecular orientation (see fig.3.4), one possible vertical mirror plane corresponds to the xz -plane, and therefore a 2d-vector in the xy -plane perpendicular to the principle rotation axis, for example the same 2d vector as considered before for the C_3 rotation (see Eq. (3.13)), changes from $(1,1)$ to $(1,-1)$, corresponding to the transformation matrix as following:

$$\begin{pmatrix} 1 \\ -1 \end{pmatrix} = \begin{pmatrix} 1 & 0 \\ 0 & -1 \end{pmatrix} \cdot \begin{pmatrix} 1 \\ 1 \end{pmatrix} \quad (\text{Eq.3.14})$$

Consequently, the character of this matrix equals 0, which again is in agreement with our irreducible basis E.

Next, to determine the symmetry of the vibrational modes we need to find the reducible representation for the point group C_{3v} , which again corresponds to the overall symmetry of all $3N$ molecular degrees of freedom (translation, rotation, and vibration).

Consider for example the HCCl_3 molecule: the previous example C_{2v} has taught us that we only have to consider those atoms of the molecule, which are not changing their position under the symmetry operation, to determine the character of the respective transformation matrix. For symmetry operation E, all 5 atoms of HCCl_3 stay at their position, leading to a character of $5 \times 3 = 15$. Rotation around the z-axis by 120° , on the other hand, only leaves the H-atom and the central C-atom at their original positions. The z vectors of these atoms remain unchanged, whereas the x- and y-position vectors are changing from +1 to $-\frac{1}{2}$, respectively ($\sin^{-1}(30^\circ)$). The character for the C_3 transformation matrix therefore has to be 0. Finally, there exist three equivalent vertical mirror planes defined by the atoms H, C and one of the 3 Cl atoms, respectively. Consequently, only the positions of these 3 atoms within the mirror plane remain unchanged, with two Cartesian components lying within the plane remaining unchanged as well, and the third component lying perpendicular to the mirror plane changing its sign. For the transformation matrix corresponding to σ_v , this leads us to a character of 3.

C_{3v}	E	$2 C_3$	$3 \sigma_v$
Γ	15	0	3

Table 3.4: characters of the reducible representations for the symmetry operations of symmetry point group C_{3v} (e.g. HCCl_3 molecule)

Using the above formula (Eq. 3.9)), the reducible representation is then given as:

$$\Gamma = 4 \cdot A_1 + A_2 + 5 \cdot E \quad (\text{Eq.3.15})$$

To identify the symmetry of the vibrational modes, next we have to subtract the irreducible representations corresponding in symmetry to the translational and rotational modes. According to the character table shown above (see tab.3.3), the translations x, y and z have the symmetries of A_2 and E, whereas the rotations around the 3 different Cartesian axes R_x , R_y and R_z also have the symmetries of A_2 and E. Subtracting these 6 irreducible representations from the reducible expression given in Eq.(3.15) then leads us to the following symmetries for the vibrational modes of the HCCl_3 molecule:

$$\Gamma_{vib} = 3 \cdot A_1 + 3 \cdot E \quad (\text{Eq.3.16})$$

Finally, again we have to determine which of these vibrations are detectable by spectroscopic methods. As before, we use the right column of the character table to analyze the symmetry of the irreducible representations in respect to the symmetry of an electric dipole moment, which is a vector (x , y or z), or the symmetry of the polarizability, which is a tensor and therefore described by products x^2 , y^2 , z^2 or xy , xz , yz (or linear combinations of these products).

C_{3v}	E	$2 C_3$	$3 \sigma_v$	
A_1	1	1	1	z ; x^2+y^2 ; z^2
A_2	1	1	-1	R_z
E	2	-1	0	(x, y) ; (R_x, R_y) ; (x^2-y^2, xy) ; (xz, yz)

Table 3.3: character table of symmetry point group C_{3v} (e.g. HCCl_3 molecule). Marked in red are IR active vibrational modes, marked in green are Raman active vibrational modes.

The character table shows that both the A_1 modes and the E modes correspond in symmetry to Cartesian coordinates as well as to products of Cartesian coordinates. We therefore may conclude that in case of HCCl_3 6 peaks are visible in both IR and Raman spectroscopy, corresponding to a total of 9 vibrational modes, 3 of which are degenerate in transition energy (symmetry class E).



Discover the truth at www.deloitte.ca/careers

Deloitte.

© Deloitte & Touche LLP and affiliated entities.



Click on the ad to read more

3.3 T_d

We conclude this chapter with a more complicated but important symmetry point group, T_d , as an example for tetrahedral molecules, like CH_4 or CCl_4 . These molecules have a total of $3N = 15$ molecular degrees of freedom, and correspondingly up to 9 vibrational transitions detectable in spectroscopy. Consequently, as in the last example, group theory becomes even more essential to analyze these modes in respect to their symmetry, and their spectroscopic detectability, since it is impossible to visualize these vibrational modes by simply looking at the molecule, which might still work for simple 3-atomic molecules like H_2O or CO_2 .

The character table of the group T_d is given in table 3.5.:

T_d	E	$8 C_3$	$3 C_2$	$6 S_4$	$6 \sigma_d$	
A_1	1	1	1	1	1	$x^2 + y^2 + z^2$
A_2	1	1	1	-1	-1	
E	2	-1	2	0	0	$(2z^2 - x^2 - y^2, x^2 - y^2)$
T_1	3	0	-1	1	-1	(R_x, R_y, R_z)
T_2	3	0	-1	-1	1	$(x, y, z); (xy, xz, yz)$

Table 3.5.: character table of symmetry point group T_d (e.g. $CHCl_3$ molecule)

We also use the point group T_d to introduce some fundamental new symmetry operations, rotation mirror axes S_4 (= rotation by 90° around a rotation axis, and then application of a mirror plane perpendicular to this axis), and diagonal mirror planes s_d (see figure 3.6, two Cl atoms and the central C atom lie within each of the 6 mirror planes, respectively). The S_4 symmetry operation, which is a bit complicated to visualize, therefore is sketched in the following figure 3.6 as well.

Importantly, the point group T_d does not have one principle rotation axis, like the groups C_{2v} or C_{3v} which we have described before, but 4. Therefore, the z-coordinate, which typically is identified with the principle axis of the molecules, has no absolute meaning in this case. Instead, we consider for example a 3d-vector (x, y, z) , or the length of this vector squared, $x^2 + y^2 + z^2$ (see Table 3.5, right column), as examples for the irreducible bases of the point group T_d , the z-component this time not necessarily pointing in the direction of the respective principle axis of the molecule.

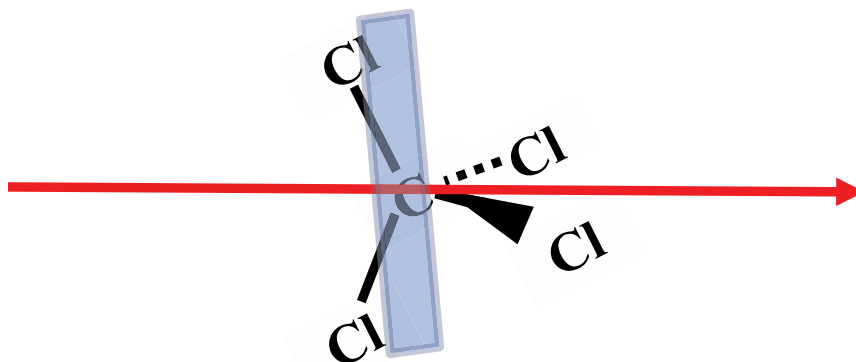

Figure 3.6: CCl_4 molecule, and one of 4 existing S_4 axes.

Note that in this character table, again we find a new letter for the irreducible representations, T. This letter T corresponds to a 3d irreducible representation, like the Cartesian vector (x, y, z) .

Next, we need to find the characters of one reducible representation. Again, we only have to consider the atoms of the molecule which are not changing their position under the symmetry operation to determine the character of the respective transformation matrix. For symmetry operation E , all 5 atoms of CCl_4 stay at their position, leading to a character of $5 \times 3 = 15$. Rotation around any of the 3 C_2 axes, on the other hand, only leaves the central C-atom at its original position. The z vector of the C atom remains unchanged, whereas the x- and y-position vectors are changing from +1 to -1, respectively, giving a total of -1 for the character of the C_2 operation (see table). The character for the C_3 transformation matrix in case of T_d has to be 0, as shown before in case of C_{3v} . For S_4 , again only the central C atom does not relocate, and its z-vector changes from +1 to -1, whereas x and y vectors become y vector and -x vector, respectively, leading to diagonal transformation matrix elements of 0 for these two coordinates. The character for the S_4 transformation matrix therefore is -1. Finally, for the diagonal mirror planes σ_d , the central C atom and 2 of the 4 Cl atoms remain at their positions, respectively. Let us assume the plane is lying in xz, then for each of the three atoms we would get a character of 1 (x and z unchanged, y changing from +1 to -1), leading to a total character of the σ_d transformation matrix of 3. All these characters of the reducible matrix representations are summarized in the following table 3.6:

T_d	E	$8 C_3$	$3 C_2$	$6 \sigma_d$	$6 S_4$
Γ	15	0	-1	-1	3

Table 3.6: characters of the reducible representations for the symmetry operations of symmetry point group T_d (e.g. CCl_4 molecule)

Using the above formula (Eq. (3.9)), the reducible representation as a sum of the irreducible representations is given as:

$$\Gamma = A_1 + E + T_1 + 3T_2 \quad (\text{Eq.3.17})$$

To identify the symmetry of the vibrational modes, again we have to subtract the translations and rotations. According to the character table (see tab.3.5) the translations x , y and z have the symmetry of T_2 , whereas the rotations around the 3 different Cartesian axes R_x , R_y and R_z have the symmetry of T_1 . Subtracting these 6 representations (or, better, two 3d representations) then leads us to the following symmetries for the vibrational modes of the CCl_4 molecule:

$$\Gamma_{vib} = A_1 + E + 2T_2 \quad (\text{Eq.3.18})$$

Finally, once more we have to determine which of these vibrations are detectable by spectroscopic methods. Again, we consider the right column of our character table to analyze the symmetry of the irreducible representations in respect to the symmetry of an electric dipole moment, which is a vector (x , y or z), or the symmetry of the polarizability, which is a tensor and therefore described by products of type x^2 , y^2 , z^2 or xy , xz , yz .

SIMPLY CLEVER

ŠKODA



We will turn your CV into
an opportunity of a lifetime



Do you like cars? Would you like to be a part of a successful brand?
We will appreciate and reward both your enthusiasm and talent.
Send us your CV. You will be surprised where it can take you.

Send us your CV on
www.employerforlife.com



Click on the ad to read more

T_d	E	$8 C_3$	$3 C_2$	$6 S_4$	$6 \sigma_d$	
A_1	1	1	1	1	1	$x^2 + y^2 + z^2$
A_2	1	1	1	-1	-1	
E	2	-1	2	0	0	$(2z^2 - x^2 - y^2, x^2 - y^2)$
T_1	3	0	-1	1	-1	(R_x, R_y, R_z)
T_2	3	0	-1	-1	1	$(x, y, z) ; (xy, xz, yz)$

Table 3.5: character table of the symmetry point group T_d (e.g. HCCl_3 molecule), marked in red are IR active vibrational modes, marked in green are Raman active vibrational modes

The character table (see tab.3.5) shows that all irreducible representations of the vibrational modes (A_1, E, T_2) contain products of Cartesian coordinates, and therefore all vibrations should be detectable by Raman spectroscopy. In practice, we only find 4 peaks for the 9 vibrational modes, since some of them are energetically degenerate, and therefore represented by 2d (E) or 3d irreducible bases (T), respectively. Only the T_2 representation, however, corresponds to simple Cartesian coordinates x, y or z , and therefore CCl_4 should show only up to 2 peaks in an IR vibration excitation spectrum.

To conclude this section, we show a typical Raman spectrum of CCl_4 measured in our research laboratory at Mainz University. Note that we see 4 transition peaks as predicted, one of which shows a double-peak shape. Those transitions correspond to the vibrational modes as listed in Tab. 3.6.

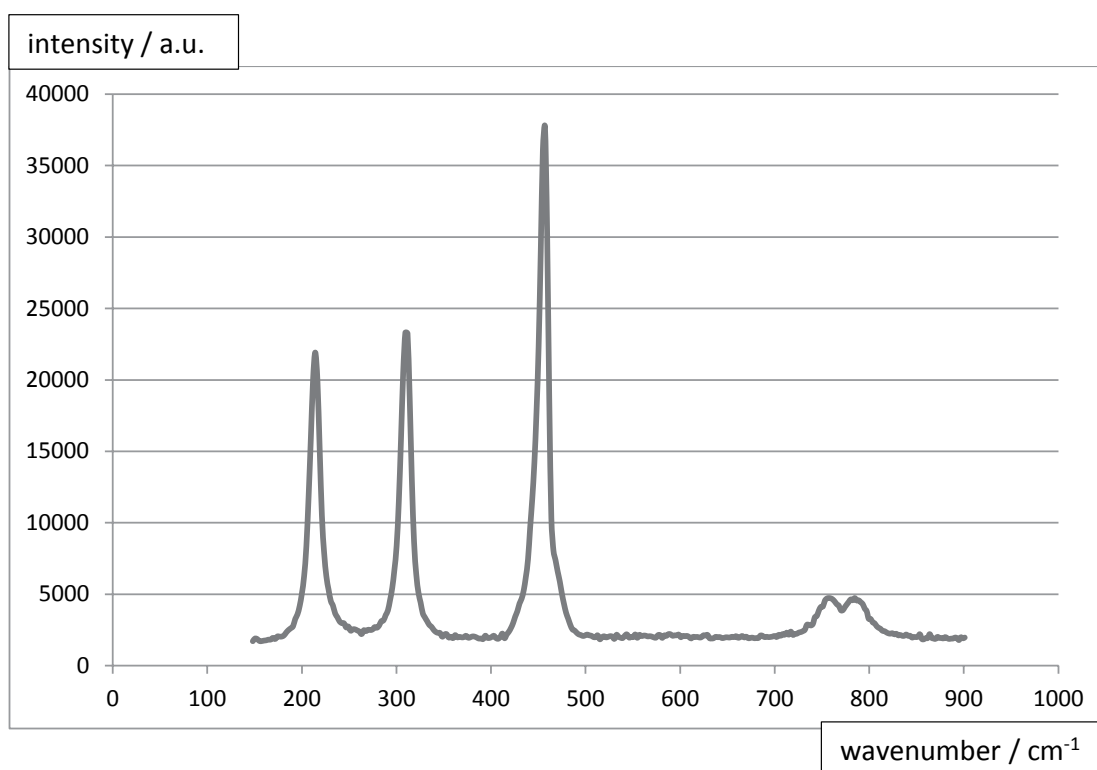

Fig.3.7: Raman spectrum of CCl_4 (University Mainz/Germany, Physical Chemistry Lab, 2015)
(Figure prepared with Microsoft Excel 2013)

Peak position shift, wavenumber/cm ⁻¹	Vibrational mode (symmetry, irreducible)
214	T ₁
319	T ₂
457	A ₁
755	E

Tab.3.6: Raman peaks and corresponding vibrational modes, see spectrum Fig. 3.7 and character table Tab. 3.5.

3.4 Group theory and excitation of molecular electronic transitions, e.g. C_{2v}

Finally, let us consider how group theory may help to decide if an electronic transition can be excited by the absorption of light. Again, for its simplicity, we use the 3-atomic molecule H₂O as an example, and therefore show the corresponding character table and the molecular orientation in 3d space again:

C _{2v}	E	C ₂	σ _v (xz)	σ' _v (yz)	
A ₁	1	1	1	1	z, x ² , y ² , z ²
A ₂	1	1	-1	-1	R _z , xy
B ₁	1	-1	1	-1	x, R _y , xz
B ₂	1	-1	-1	1	y, R _x , yz

Table 3.7: character table of symmetry point group C_{2v} (e.g. H₂O molecule)

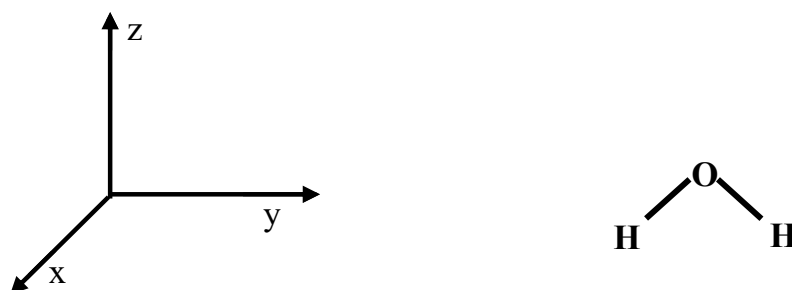

Figure 3.8: Cartesian coordinate system and corresponding orientation of the H₂O molecule.

Next, for electronic transitions we have to determine the symmetries of the molecular electron orbitals. Here, we first consider that within a simple quantum mechanical model, these molecular orbitals are obtained by linear combination of the atomic orbitals of the contributing atoms, O and 2H. We only take into account the outermost (valence) atomic orbitals, which, for the oxygen atom, are 2s, 2p_x, 2p_y, and 2p_z, and for the hydrogen atoms are 1s, respectively.

As a general rule, molecular orbitals can only be formed by combining atomic orbitals of identical symmetries. So, let us first consider the symmetries of the valence atomic orbitals, as defined in the character table C_{2v}.

We start with the oxygen atom: obviously, the $2s$ and the $2p_z$ orbitals are perfectly symmetric, and therefore correspond to the irreducible representation a_1 . Note that we will use small letters for the atomic or molecular orbitals, but capital letters for the total electronic configuration of the molecule. Next, p_x is symmetric to the xz -plane, but antisymmetric in respect to the C_2 rotation and the yz -mirror plane, therefore corresponding to the irreducible representation b_1 . Finally, p_y is symmetric to the yz -plane, but antisymmetric in respect to the C_2 rotation and the xz -mirror plane, therefore corresponding to b_2 .

For the hydrogen atoms, it is a bit more difficult to determine the symmetry, since they switch places under the symmetry operations C_2 and $s_v(xz)$, and therefore form no irreducible basis, individually. Instead, we need to consider a linear combination of the two $1s$ orbitals, which either can be totally symmetric (and therefore a_1), or antisymmetric in respect to the xz -plane, and therefore b_2 . Let us summarize the symmetry of the atomic orbitals contributing to the molecular orbitals of H_2O in the following figure 3.9:



e-learning for kids

- The number 1 MOOC for Primary Education
- Free Digital Learning for Children 5-12
- 15 Million Children Reached

About e-Learning for Kids Established in 2004, e-Learning for Kids is a global nonprofit foundation dedicated to fun and free learning on the Internet for children ages 5 - 12 with courses in math, science, language arts, computers, health and environmental skills. Since 2005, more than 15 million children in over 190 countries have benefitted from eLessons provided by EFK! An all-volunteer staff consists of education and e-learning experts and business professionals from around the world committed to making difference. eLearning for Kids is actively seeking funding, volunteers, sponsors and courseware developers; get involved! For more information, please visit www.e-learningforkids.org.

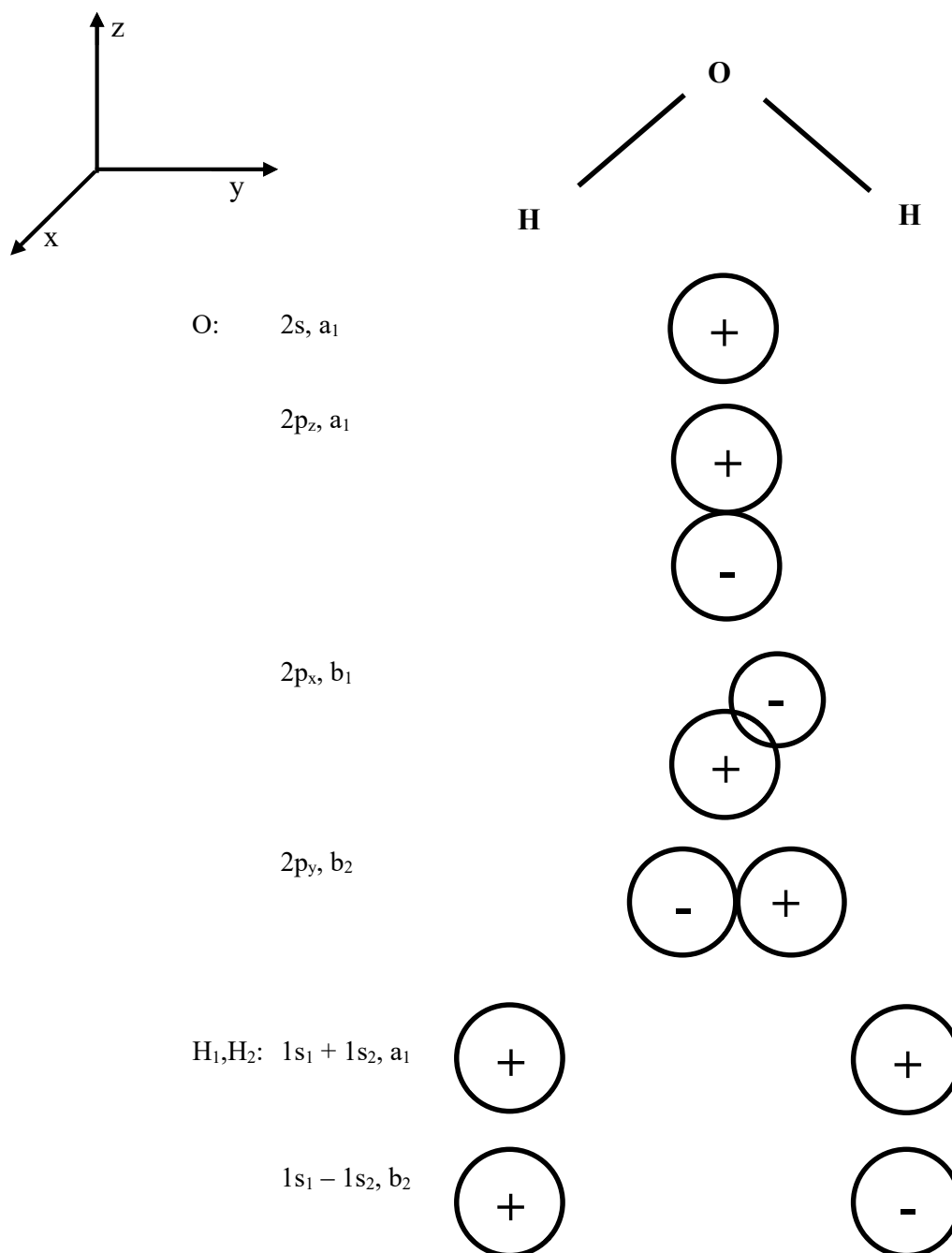

Figure 3.9: Symmetries of atomic orbitals constituting the molecular orbitals of H_2O . The sign $+$, $-$ symbolizes the phase of the corresponding wave function. Note that for the hydrogen atoms, a linear combination has to be considered to obtain an irreducible representation of the symmetry group C_{2v} .

We conclude, therefore, that the six molecular orbitals of H_2O , which are formed by linear combination of atomic orbitals of identical symmetries, respectively, belong to the following symmetry classes: $3a_1$, $2b_2$, and $1b_1$. The energy diagram and molecular orbital scheme of H_2O looks as following:

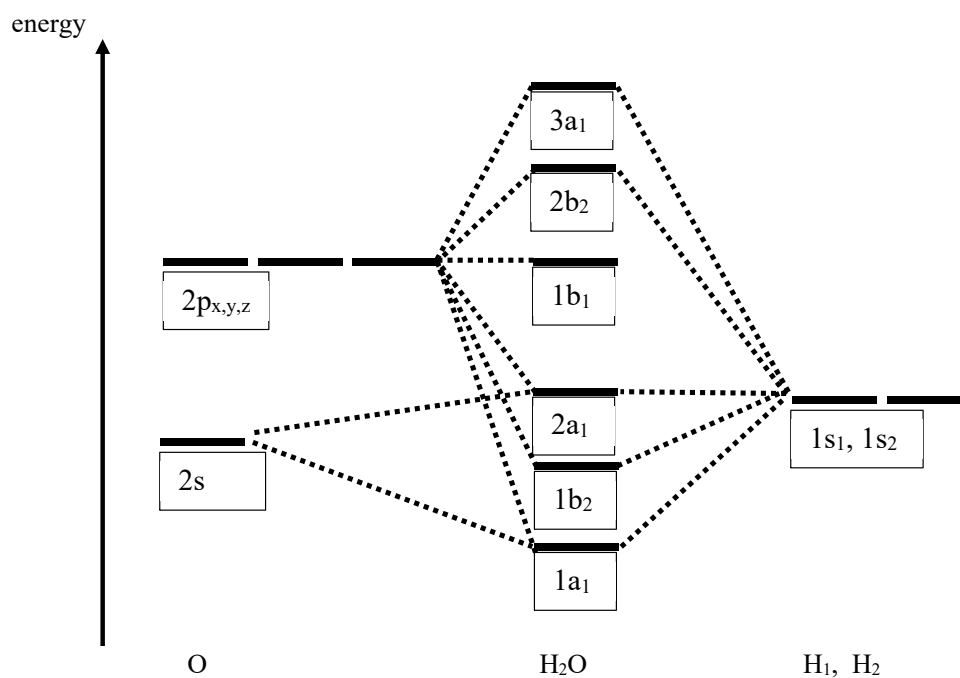

Figure 3.10: energy diagram and molecular orbital scheme of H_2O , energy levels not on quantitative scale!

Cynthia | AXA Graduate

AXA Global Graduate Program

Find out more and apply

redefining / standards AXA

Next, let us consider how some of these molecular orbitals could be visualized: $1b_1$ is comparatively simple, since it does not contain any contributions from the hydrogen atomic orbitals, which have a different symmetry. Therefore, $1b_1$ must directly correspond to the orbital $2p_x$ of the oxygen atom, which is also obvious from the fact that it shows no wave function overlap with the hydrogen orbitals. The most stable orbital $1a_1$ is symmetric, and it shows a maximum overlap of the contributing wave functions. Therefore it must be a combination of three s orbitals. Finally, we consider $1b_2$, lying lower in energy than the atomic orbitals contributing to it, and therefore corresponding to a binding orbital, and $2b_2$, lying higher in energy than the atomic orbitals and therefore antibinding. Some of the 6 molecular orbitals are sketched, according to our simple considerations, in the following figure 3.11.

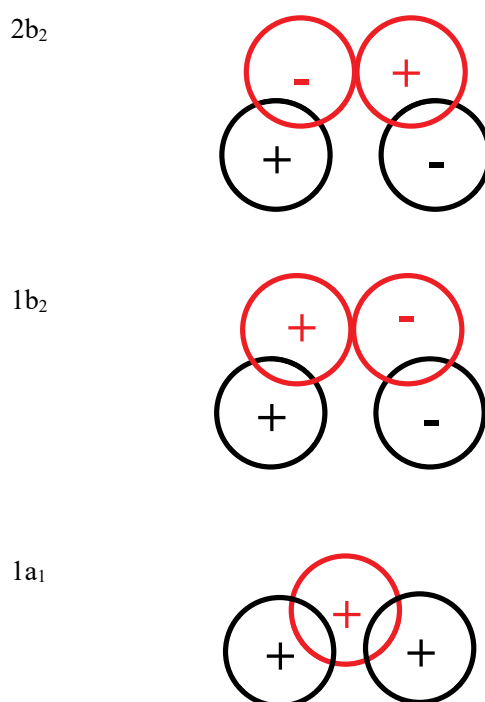

Figure 3.11: some of the molecular orbitals of the molecule H_2O . Wave functions or orbitals show constructive overlap, leading to a lower total energy of the molecular orbital system (= binding state), only if they agree in phases +, -, respectively. Atomic orbitals of the oxygen atoms are shown in red color, orbitals of the hydrogen atoms in black color.

Next, we fill the molecular orbitals with the valence electrons of the contributing atoms, starting with the one with lowest energy ($1a_1$), and determine the symmetry of the electronic state. We have a total of eight electrons (six valence electron of the oxygen atom, plus one electron each from the two hydrogen atoms), and therefore the electronic ground state of the H_2O molecule corresponds to molecular orbitals $1a_1$ to $1b_1$ each filled with two electrons. $1b_1$ is also called highest occupied molecular orbital (HOMO), and the symmetry of this electronic configuration is determined by simply multiplying the characters of the irreducible representations for all molecular orbitals occupied by electrons, leading to a representation for the electronic configuration A_1 . In general, if the orbitals are filled with 2 electrons each, we get a symmetric electronic state, since for each molecular orbital, for example $2b_2$, one has to get a symmetric state a_1 (see character table Tab 3.7, $b_2 \times b_2 = (1,1,1,1)$), corresponding to A_1 .

If we try now to excite 1 electron from the HOMO to an energetically higher molecular orbital, for example the lowest unoccupied orbital (= LUMO) $2b_2$, the symmetry of the new electronic configuration will simply be given by considering the singly occupied molecular orbitals, only. For our HOMO – LUMO – transition, we then obtain a symmetry of the excited state given by $b_1 \times b_2 = (1,1,-1,-1)$, corresponding to A_2 . Therefore, our electronic transition occurs from an electronic ground state of symmetry A_1 , to an electronically excited state of symmetry A_2 .

Now, how can one decide if this transition is optically excitable or not? The answer to this important question lies within Fermi's golden rule derived in the preceding chapter (see Eq.2.51), that for molecular transitions excited by the absorption of light, the corresponding transition electric dipole moment has to be non-zero:

$$\vec{R}_{nm} = \int f_n^*(q) \cdot \vec{\mu} f_m(q) dq \quad (\text{Eq.3.19})$$

This integral will be only non-zero if its overall symmetry is A_1 . Again, the overall symmetry can easily be determined by multiplication of the characters of the corresponding irreducible representations given in our character table, which for convenience again shall be repeated here:

C_{2v}	E	C_2	$\sigma_v(xz)$	$\sigma'_v(yz)$	
A_1	1	1	1	1	z, x^2, y^2, z^2
A_2	1	1	-1	-1	R_z, xy
B_1	1	-1	1	-1	x, R_y, xz
B_2	1	-1	-1	1	y, R_x, yz

Table 3.7: character table of symmetry point group C_{2v} (e.g. H_2O molecule). Symmetries of the dipole moment are marked in yellow.

Our HOMO-LUMO transition combines wave functions $f_m(q)$ (HOMO) and $f_n^*(q)$ (LUMO), with symmetries A_1 and A_2 , as we have just shown in detail. Further, the dipole moment operator has the symmetries of a vector in the Cartesian coordinate system, i.e. either A_1 , B_1 or B_2 . Therefore, we have to check if any of the combinations $A_2 \times A_1 \times A_1$, $A_2 \times B_1 \times A_1$, $A_2 \times B_2 \times A_1$, leads to a total symmetry A_1 , so the integral in Eq.(3.19) becomes non-zero. The multiplication of irreducible representations, or corresponding characters, has to be done pairwise, leading to:

$$A_2 \cdot A_1 \cdot A_1 = (A_2 \cdot A_1) \cdot A_1 = A_2 \cdot A_1 = A_2 \quad (\text{Eq.3.20.1})$$

$$A_2 \cdot B_1 \cdot A_1 = (A_2 \cdot B_1) \cdot A_1 = B_2 \cdot A_1 = B_2 \quad (\text{Eq.3.20.2})$$

$$A_2 \cdot B_2 \cdot A_1 = (A_2 \cdot B_2) \cdot A_1 = B_1 \cdot A_1 = B_1 \quad (\text{Eq.3.20.3})$$

Let us confirm Eq.(3.20.2) in detail: the characters for the first product $A_2 \cdot B_1$ according to Tab.3.7 are given as following:

$$\chi(A_2 \cdot B_1) = (1 \cdot 1, 1 \cdot (-1), (-1) \cdot 1, (-1) \cdot (-1)) = (1, -1, -1, 1) = \chi(B_2) \quad (\text{Eq.3.21})$$

Obviously, multiplication of any irreducible representation X with the symmetric representation A_1 yields X. Therefore, $B_2 \cdot A_1 = B_2$.

None of the combinations given in Eqs.(3.20) therefore results in A_1 , leading us to the conclusion that the HOMO-LUMO transition of H_2O molecules cannot be excited by the absorption of light. This conclusion underlines how convenient the concept of symmetry group theory is for the interpretation and understanding of the optical spectra of molecules. Note that, in the context of this booklet, for simplicity we have taken simple calculation rules how to handle symmetries of combined states, like, for example, $A_2 \cdot B_1 \cdot A_1 = (A_2 \cdot B_1) \cdot A_1 = A_2 \cdot (B_1 \cdot A_1)$, for granted. All these rules of course can be justified in a mathematically exact way, but I felt this to be beyond the intention of this book, and therefore must refer the readers more interested in the mathematical details of group theory to common textbooks of physical chemistry.

Let me conclude this section by considering if the electronic transition of higher energy, i.e. from the HOMO of our H_2O molecule, not to the LUMO, but to the next unoccupied $3a_1$ molecular orbital, can be triggered by light absorption or not. The excited state in this case has the symmetry defined by singly occupied orbitals of symmetries b_1 and a_1 , respectively, leading simply to the symmetry B_1 for the electronic configuration of this excited state. Combinations to be considered for the transition dipole moment then are given as following:

$$B_1 \cdot \begin{Bmatrix} B_1 \\ B_2 \\ A_1 \end{Bmatrix} \cdot A_1 \quad (\text{Eq.3.22})$$

with the symmetries of the Cartesian components of the electric dipole momentum operator given as

$$\vec{\mu} = \begin{Bmatrix} \mu_x \\ \mu_y \\ \mu_z \end{Bmatrix} = \begin{Bmatrix} x \\ y \\ z \end{Bmatrix} = \begin{Bmatrix} B_1 \\ B_2 \\ A_1 \end{Bmatrix} \quad (\text{Eq.3.23})$$

We immediately recognize that the first combination, $B_1 \cdot B_1 \cdot A_1$, leads to a total symmetry of A_1 . Therefore, this electronic transition is accessible by absorption of light via the x-component of the electric dipole moment vector.

Index

A

Absorption, of light, 42, 44, 66, 89

Absorption spectroscopy, 43f, 49f

B

Boltzmann statistics, 10f

Bond, chemical,

length, 27, 44, 56

strength, 27, 29, 59

C

Cl₂, bond length, 20

Character table,

C_{2v}, 67, 74

C_{3v}, 75, 78

Td, 79, 82

Characteristic temperature,

vibration of molecules, 27, 29

rotation of molecules, 27, 29

Chemical equilibrium, statistical treatment, 29f

Complex numbers, 35f

Constant,

Boltzmann, 12

Planck, 42

D

Degrees of freedom, molecular, 66, 72, 77

Dipole,

induced, 65

transition moment, 53

Dissociation, of diatomic molecules, 33

Doppler effect, 47

E

Eigenfunktionen, wave functions, 15, 44, 50f

Energy,

quantized oscillator, 16

quantized particle in a box, 15

I joined MITAS because
I wanted **real responsibility**

The Graduate Programme
for Engineers and Geoscientists
www.discovermitas.com



Month 16

I was a construction
supervisor in
the North Sea
advising and
helping foremen
solve problems

Real work
International opportunities
Three work placements



 **MAERSK**



Click on the ad to read more

- quantized rotator, 17
- relation to partition function, 21f
- Entropy, statistical definition, 25
- Equilibrium, chemical, 29f
- Euler equations, 37
- F**
- Fermi's golden rule, 55
- Fluorescence, 44
- Frequency,
 - electronic transition, 43,44
 - molecular vibration, 43,44
 - molecular rotation, 43
- Function,
 - partition, 13f
 - wave, 15, 44, 50f
- G**
- Group theory, 67f
- H**
- HCl, IR spectrum, 58, 61
- H₂O, molecular orbital scheme, 85, 86
- Heat capacity,
 - of gases, 26f
 - relation to partition function, 27, 28
- I**
- Internal conversion, 56
- Intersystem crossing, 56
- IR spectroscopy,
 - high resolution, 58f
 - vibration rotation coupling, 60, 61
- J**
- Jablonski diagram, 56
- K**
- Kinetic theory of the ideal gas, 47
- L**
- Law,
 - Boltzmann's, 13, 30
 - Fermi's, 46, 55
- Light,
 - absorption (see absorption, of light)
 - energy spectrum, 43
- M**
- Molecular orbital scheme, 83f
- Morse potential, 44, 61
- O**
- Orbitals, molecular, 83f
- Oscillator,
 - linear harmonic, 16
 - linear anharmonic, 44, 61
- P**
- Particle in the box, 14f
- Partition function,
 - electronic state, 33
 - molecular translation, 18
 - molecular rotation, 19
 - molecular vibration, 20
 - relation to energy, 21f
 - relation to entropy, 25
 - relation to free energy, 23, 24
 - relation to heat capacity, 23, 26f
- Perturbation, quantum theory of, 52f
- Phosphorescence, 58
- Polarisability tensor, 65, 74, 78, 81
- Q**
- Quantum numbers, 16, 17
- Quantum theory, 14f
- R**
- Radiation,
 - absorption, see absorption of light
 - emission, 42, 56f
- Raman effect, 63f
- Rate constants,
 - electronic transitions, 43, 44
 - fluorescence, 58
 - internal conversion, 58
 - molecular rotations, 43

- molecular vibrations, 43, 44
- phosphorescence, 58
- Reduces mass, vibration, 59
- Representation of symmetry operation,
 - irreducible, 69
 - reducible, 69f,
- Rotation, quantum states, 17
- Rotation constant,
 - quantum mechanical model, 17, 29
 - IR spectrum, 60f
- S**
- Scattering of light,
 - Rayleigh, 63f
 - Raman, 63f
- Schrödinger equation,
 - stationary, 50
 - time dependent, 50
- Selection rules,
 - light absorption spectroscopy, 49, 55, 59, 66
 - Raman scattering, 66
- Series, spectral, 61
- Singlet state, 58
- Spectra/Spectroscopy
 - IR, 58f
 - molecular, 42f
 - Raman, 63f
 - UV/vis, 44f, 56f
- Spin orbit coupling, 58
- Stirling approximation, 10
- Symmetry operations, 67, 79
 - rotation,
 - irreducible matrix representation, 76
 - reducible matrix representation, 70
 - mirror plane,
 - irreducible matrix representation, 76
- T**
- Temperature,
 - absolute, 12
 - statistical definition, 12
 - molecular transitions, 27, 29
- Transition, dipole moment, 53, 55
- Triplet state, 58
- U**
- Uncertainty principle, Heisenberg, 16, 47
- V**
- Vibration, linear harmonic, see oscillator